

BOX HB



HELICOIDAL EN CAJA INSONORIZADA

CARACTERÍSTICAS CONSTRUCTIVAS:

• **BOX:** Caja construida en chapa de acero galvanizado con aislamiento térmico y acústico con clasificación al fuego Bs1d0. Paneles laterales desmontables para facilitar el acceso al motor y el mantenimiento.

• **Ventilador Interior:** HB : ventilador helicoidal de marco redondo reforzado con nervio intermedio para tamaños del 45 al 80. Para tamaños del 90 a 125 es un HC .

Montaje modular del conjunto motor hélice que permite una total versatilidad en caso de cualquier cambio. Hélice de poliamida reforzada con fibra de vidrio de ángulo variable en origen. Protegidos contra la corrosión mediante recubrimiento en polvo de resina poliéster

• **Motor** asíncrono normalizado de jaula de ardilla con protección IP-55 y aislamiento clase F. Voltajes estándar 230V 60Hz para motores monofásicos, 230/400-460V 60Hz para motores trifásicos hasta 4kW y 400-460/690V 60Hz para potencias superiores de una velocidad y 400V 50Hz para motores de 2 velocidades.

APLICACIONES:

Diseñados para montaje en pared o en conducto, en interior o intemperie, son indicados para:

- Renovación de aire en todo tipo de edificios e industrias.
- Extracción de humos
- Temperatura máxima de trabajo en continuo: monofásicos 50°C, trifásicos 60°C.

BAJO DEMANDA:

- Hélice reversible.
- Hélice impelente (sentido del aire hélice-motor).
- Tensiones especiales

Accesorios



AVR

AVS

INT

JE 45



SFC

Información técnica

Motor Monofásico / 4 polos

Código	Modelo	Ángulo	Min. Pot. Nominal kW	Max. Pot. Nominal kW	Caudal máx. m3/h	Sonido db(A)*	Peso	Esquema de conexiones
-	BOX HB 45 M4 (A0:6)	25º - 30º	0,25	0,25	5.500	55	55,40	1
-	BOX HB 50 M4 (A0:6)	25º - 30º	0,37	0,37	7.080	59	59,80	1
-	BOX HB 56 M4 (A2:6)	20º - 25º	0,37	0,75	9.930	57	79	2
-	BOX HB 56 M4 (A2:9)	20º - 20º	0,37	0,75	7.890	57	80	2
-	BOX HB 56 M4 (A5:6)	20º - 25º	0,37	0,75	10.510	62	78,10	2

Motor Monofásico / 6 polos

Código	Modelo	Ángulo	Min. Pot. Nominal kW	Max. Pot. Nominal kW	Caudal máx. m3/h	Sonido db(A)*	Peso	Esquema de conexiones
-	BOX HB 45 M6 (A0:6)	25º - 40º	0,12	0,12	4.930	46	55,40	1
-	BOX HB 50 M6 (A0:6)	25º - 30º	0,12	0,12	4.590	50	59,80	1
-	BOX HB 56 M6 (A2:6)	20º - 45º	0,25	0,75	10.800	47	79	2
-	BOX HB 56 M6 (A2:9)	20º - 45º	0,25	0,75	11.410	49	80	2
-	BOX HB 56 M6 (A5:6)	20º - 45º	0,25	0,75	11.710	68	78,10	2

Motor Trifásico / 4 polos

Código	Modelo	Ángulo	Min. Pot. Nominal kW	Max. Pot. Nominal kW	Caudal máx. m3/h	Sonido db(A)*	Peso*	Esquema de conexiones
-	BOX HB 45 T4 (A0:6)	25º - 30º	0,25	0,25	5.500	55	55,40	2
-	BOX HB 50 T4 (A0:6)	25º - 30º	0,37	0,37	7.080	59	59,80	2
-	BOX HB 56 T4 (A2:6)	20º - 45º	0,37	1,50	16.600	57	79	2
-	BOX HB 56 T4 (A2:9)	20º - 45º	0,37	2,20	17.610	58	80	2
-	BOX HB 56 T4 (A5:6)	20º - 45º	0,37	1,50	17.560	72	78,10	2
-	BOX HB 63 T4 (A2:6)	20º - 45º	0,55	3	24.010	59	83,20	2
-	BOX HB 63 T4 (A2:9)	20º - 45º	0,55	3	26.110	61	84,40	2
-	BOX HB 63 T4 (A5:6)	20º - 45º	0,55	3	24.410	76	82,30	2
-	BOX HB 71 T4 (A2:6)	20º - 45º	0,75	4	33.410	64	106,50	2
-	BOX HB 71 T4 (A2:9)	20º - 45º	0,75	4	36.310	66	107,80	2

Código	Modelo	Ángulo	Min. Pot. Nomin al kW	Max. Pot. Nomin al kW	Caudal máx. m3/h	Sonido db(A)*	Peso*	Esquema de conexiones
-	BOX HB 71 T4 (A5:6)	20º - 45º	0,75	3	33.020	81	105,50	2
-	BOX HB 80 T4 (A2:6)	20º - 45º	1,10	5,50	46.710	64	112,30	2
-	BOX HB 80 T4 (A2:9)	20º - 45º	1,10	5,50	50.010	72	113,70	2
-	BOX HB 80 T4 (A5:6)	20º - 45º	1,10	4	45.340	77	111,20	2
-	BOX HB 90 T4 (A6:3)	20º - 42º	3	15	61.020	73	172,30	2
-	BOX HB 90 T4 (A6:6)	20º - 42º	3	15	69.810	74	174,50	2
-	BOX HB 100 T4 (A6:3)	20º - 42º	5,50	22	83.030	74	186,10	2
-	BOX HB 100 T4 (A6:6)	20º - 42º	5,50	22	97.210	64	188,60	2
-	BOX HB 112 T4 (A6:3)	20º - 42º	5,50	30	109.900	76	249,30	2
-	BOX HB 112 T4 (A6:6)	20º - 42º	5,50	30	130.010	79	252,20	2
-	BOX HB 125 T4 (A7:4)	20º - 42º	11	45	158.010	84	264,10	2
-	BOX HB 125 T4 (A7:8)	20º - 42º	11	45	181.010	89	268,10	2

Motor Trifásico / 6 polos

Código	Modelo	Ángulo	Min. Pot. Nomin al kW	Max. Pot. Nomin al kW	Caudal máx. m3/h	Sonido db(A)*	Peso*	Esquema de conexiones
-	BOX HB 45 T6 (A0:6)	25º - 40º	0,12	0,12	4.930	46	55,40	2
-	BOX HB 50 T6 (A0:6)	25º - 30º	0,18	0,18	4.590	50	59,80	2
-	BOX HB 56 T6 (A2:6)	20º - 45º	0,25	0,55	10.800	47	79	2
-	BOX HB 56 T6 (A2:9)	20º - 45º	0,25	0,55	11.410	49	80	2
-	BOX HB 56 T6 (A5:6)	20º - 45º	0,25	0,55	11.710	68	78,10	2
-	BOX HB 63 T6 (A2:6)	20º - 45º	0,37	0,75	15.610	49	83,20	2
-	BOX HB 63 T6 (A2:9)	20º - 45º	0,37	0,75	16.910	52	84,40	2
-	BOX HB 63 T6 (A5:6)	20º - 45º	0,37	0,75	16.280	72	82,30	2
-	BOX HB 71 T6 (A2:6)	20º - 45º	0,55	1,10	21.610	54	106,50	2
-	BOX HB 71 T6 (A2:9)	20º - 45º	0,55	1,10	23.510	57	107,80	2
-	BOX HB 71 T6 (A5:6)	20º - 45º	0,55	1,10	22.010	77	105,50	2
-	BOX HB 80 T6 (A2:6)	20º - 45º	0,75	2,20	30.210	55	112,30	2
-	BOX HB 80 T6 (A2:9)	20º - 45º	0,75	2,20	32.410	62	113,70	2
-	BOX HB 80 T6 (A5:6)	20º - 45º	0,75	2,20	30.230	74	111,20	2
-	BOX HB 90 T6 (A6:3)	20º - 42º	1,50	4	39.480	63	172,30	2
-	BOX HB 90 T6 (A6:6)	20º - 42º	1,50	4	45.110	64	174,50	2

Código	Modelo	Ángulo	Min. Pot. Nomin al kW	Max. Pot. Nomin al kW	Caudal máx. m3/h	Sonido db(A)*	Peso*	Esquema de conexiones
-	BOX HB 100 T6 (A6:3)	20º - 42º	2,20	7,50	45.110	64	186,10	2
-	BOX HB 100 T6 (A6:6)	20º - 42º	2,20	7,50	62.910	68	188,60	2
-	BOX HB 112 T6 (A6:3)	20º - 42º	3	11	71.360	66	249,30	2
-	BOX HB 112 T6 (A6:6)	20º - 42º	3	11	84.210	69	252,20	2
-	BOX HB 125 T6 (A7:4)	20º - 42º	3	15	102.010	75	264,10	2
-	BOX HB 125 T6 (A7:8)	20º - 42º	3	15	117.010	80	268,10	2

Notas:

* El peso del ventilador no incluye el motor

** Nivel de presión sonora total en el punto de caudal máximo medido en dB(A) en la aspiración, medido en campo libre a una distancia de 6m de la fuente

Dimensiones

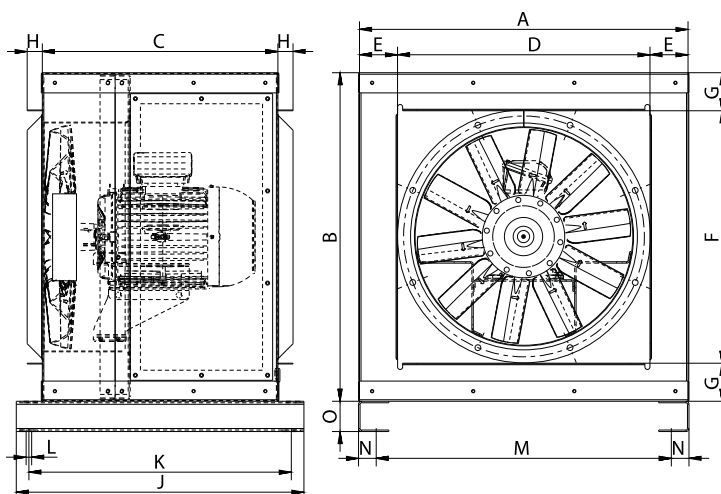

Modelo	A	B	C	D	E	F	G	H	J
BOX HB 45 M4 (A0:6)	651	651	467	500	75	500	75	30	570
BOX HB 45 M6 (A0:6)	651	651	467	500	75	500	75	30	570
BOX HB 45 T4 (A0:6)	651	651	467	500	75	500	75	30	570
BOX HB 45 T6 (A0:6)	651	651	467	500	75	500	75	30	570
BOX HB 50 M4 (A0:6)	651	651	467	500	75	500	75	30	570
BOX HB 50 M6 (A0:6)	651	651	467	500	75	500	75	30	570
BOX HB 50 T4 (A0:6)	651	651	467	500	75	500	75	30	570
BOX HB 50 T6 (A0:6)	651	651	467	500	75	500	75	30	570
BOX HB 56 M4 (A2:6)	781,5	781,5	542	630	76	630	76	30	665
BOX HB 56 M4 (A2:9)	781,5	781,5	542	630	76	630	76	30	665
BOX HB 56 M4 (A5:6)	781,5	781,5	542	630	76	630	76	30	665
BOX HB 56 M6 (A2:6)	781,5	781,5	542	630	76	630	76	30	665
BOX HB 56 M6 (A2:9)	781,5	781,5	542	630	76	630	76	30	665
BOX HB 56 M6 (A5:6)	781,5	781,5	542	630	76	630	76	30	665
BOX HB 56 T4 (A2:6)	781,5	781,5	542	630	76	630	76	30	665
BOX HB 56 T4 (A2:9)	781,5	781,5	542	630	76	630	76	30	665
BOX HB 56 T4 (A5:6)	781,5	781,5	542	630	76	630	76	30	665
BOX HB 56 T6 (A2:6)	781,5	781,5	542	630	76	630	76	30	665
BOX HB 56 T6 (A2:9)	781,5	781,5	542	630	76	630	76	30	665
BOX HB 56 T6 (A5:6)	781,5	781,5	542	630	76	630	76	30	665
BOX HB 63 T4 (A2:6)	781,5	781,5	542	630	76	630	76	30	665
BOX HB 63 T4 (A2:9)	781,5	781,5	542	630	76	630	76	30	665
BOX HB 63 T4 (A5:6)	781,5	781,5	542	630	76	630	76	30	665
BOX HB 63 T6 (A2:6)	781,5	781,5	542	630	76	630	76	30	665
BOX HB 63 T6 (A2:9)	781,5	781,5	542	630	76	630	76	30	665

Modelo	A	B	C	D	E	F	G	H	J
BOX HB 63 T6 (A5:6)	781,5	781,5	542	630	76	630	76	30	665
BOX HB 71 T4 (A2:6)	951,5	951,5	597	800	76	800	76	30	705
BOX HB 71 T4 (A2:9)	951,5	951,5	597	800	76	800	76	30	705
BOX HB 71 T4 (A5:6)	951,5	951,5	597	800	76	800	76	30	705
BOX HB 71 T6 (A2:6)	951,5	951,5	597	800	76	800	76	30	705
BOX HB 71 T6 (A2:9)	951,5	951,5	597	800	76	800	76	30	705
BOX HB 71 T6 (A5:6)	951,5	951,5	597	800	76	800	76	30	705
BOX HB 80 T4 (A2:6)	951,5	951,5	597	800	76	800	76	30	705
BOX HB 80 T4 (A2:9)	951,5	951,5	597	800	76	800	76	30	705
BOX HB 80 T4 (A5:6)	951,5	951,5	597	800	76	800	76	30	705
BOX HB 80 T6 (A2:6)	951,5	951,5	597	800	76	800	76	30	705
BOX HB 80 T6 (A2:9)	951,5	951,5	597	800	76	800	76	30	705
BOX HB 80 T6 (A5:6)	951,5	951,5	597	800	76	800	76	30	705
BOX HB 90 T4 (A6:3)	1176,5	1176,5	857	1000	88	1000	88	30	965
BOX HB 90 T4 (A6:6)	1176,5	1176,5	857	1000	88	1000	88	30	965
BOX HB 90 T6 (A6:3)	1176,5	1176,5	857	1000	88	1000	88	30	965
BOX HB 90 T6 (A6:6)	1176,5	1176,5	857	1000	88	1000	88	30	965
BOX HB 100 T4 (A6:3)	1176,5	1176,5	857	1000	88	1000	88	30	965
BOX HB 100 T4 (A6:6)	1176,5	1176,5	857	1000	88	1000	88	30	965
BOX HB 100 T6 (A6:3)	1176,5	1176,5	857	1000	88	1000	88	30	965
BOX HB 100 T6 (A6:6)	1176,5	1176,5	857	1000	88	1000	88	30	965
BOX HB 112 T4 (A6:3)	1416,5	1413,5	1019	1250	83	1250	82	30	1125
BOX HB 112 T4 (A6:6)	1416,5	1413,5	1019	1250	83	1250	82	30	1125
BOX HB 112 T6 (A6:3)	1416,5	1413,5	1019	1250	83	1250	82	30	1125
BOX HB 112 T6 (A6:6)	1416,5	1413,5	1019	1250	83	1250	82	30	1125
BOX HB 125 T4 (A7:4)	1416,5	1413,5	1019	1250	83	1250	82	30	1125
BOX HB 125 T4 (A7:8)	1416,5	1413,5	1019	1250	83	1250	82	30	1125
BOX HB 125 T6 (A7:4)	1416,5	1413,5	1019	1250	83	1250	82	30	1125
BOX HB 125 T6 (A7:8)	1416,5	1413,5	1019	1250	83	1250	82	30	1125

Modelo	K	L	M	N	O
BOX HB 45 M4 (A0:6)	520	11	585	35	60
BOX HB 45 M6 (A0:6)	520	11	585	35	60
BOX HB 45 T4 (A0:6)	520	11	585	35	60
BOX HB 45 T6 (A0:6)	520	11	585	35	60
BOX HB 50 M4 (A0:6)	520	11	585	35	60
BOX HB 50 M6 (A0:6)	520	11	585	35	60
BOX HB 50 T4 (A0:6)	520	11	585	35	60
BOX HB 50 T6 (A0:6)	520	11	585	35	60
BOX HB 56 M4 (A2:6)	610	11	715	35	60

Modelo	K	L	M	N	O
BOX HB 56 M4 (A2:9)	610	11	715	35	60
BOX HB 56 M4 (A5:6)	610	11	715	35	60
BOX HB 56 M6 (A2:6)	610	11	715	35	60
BOX HB 56 M6 (A2:9)	610	11	715	35	60
BOX HB 56 M6 (A5:6)	610	11	715	35	60
BOX HB 56 T4 (A2:6)	610	11	715	35	60
BOX HB 56 T4 (A2:9)	610	11	715	35	60
BOX HB 56 T4 (A5:6)	610	11	715	35	60
BOX HB 56 T6 (A2:6)	610	11	715	35	60
BOX HB 56 T6 (A2:9)	610	11	715	35	60
BOX HB 56 T6 (A5:6)	610	11	715	35	60
BOX HB 63 T4 (A2:6)	610	11	715	35	60
BOX HB 63 T4 (A2:9)	610	11	715	35	60
BOX HB 63 T4 (A5:6)	610	11	715	35	60
BOX HB 63 T6 (A2:6)	610	11	715	35	60
BOX HB 63 T6 (A2:9)	610	11	715	35	60
BOX HB 63 T6 (A5:6)	610	11	715	35	60
BOX HB 71 T4 (A2:6)	650	11	885	35	60
BOX HB 71 T4 (A2:9)	650	11	885	35	60
BOX HB 71 T4 (A5:6)	650	11	885	35	60
BOX HB 71 T6 (A2:6)	650	11	885	35	60
BOX HB 71 T6 (A2:9)	650	11	885	35	60
BOX HB 71 T6 (A5:6)	650	11	885	35	60
BOX HB 80 T4 (A2:6)	650	11	885	35	60
BOX HB 80 T4 (A2:9)	650	11	885	35	60
BOX HB 80 T4 (A5:6)	650	11	885	35	60
BOX HB 80 T6 (A2:6)	650	11	885	35	60
BOX HB 80 T6 (A2:9)	650	11	885	35	60
BOX HB 80 T6 (A5:6)	650	11	885	35	60
BOX HB 90 T4 (A6:3)	915	11	1110	35	90
BOX HB 90 T4 (A6:6)	915	11	1110	35	90
BOX HB 90 T6 (A6:3)	915	11	1110	35	90
BOX HB 90 T6 (A6:6)	915	11	1110	35	90
BOX HB 100 T4 (A6:3)	915	11	1110	35	90
BOX HB 100 T4 (A6:6)	915	11	1110	35	90
BOX HB 100 T6 (A6:3)	915	11	1110	35	90
BOX HB 100 T6 (A6:6)	915	11	1110	35	90
BOX HB 112 T4 (A6:3)	1075	11	1350	35	90
BOX HB 112 T4 (A6:6)	1075	11	1350	35	90
BOX HB 112 T6 (A6:3)	1075	11	1350	35	90

Modelo	K	L	M	N	O
BOX HB 112 T6 (A6:6)	1075	11	1350	35	90
BOX HB 125 T4 (A7:4)	1075	11	1350	35	90
BOX HB 125 T4 (A7:8)	1075	11	1350	35	90
BOX HB 125 T6 (A7:4)	1075	11	1350	35	90
BOX HB 125 T6 (A7:8)	1075	11	1350	35	90

Esquema eléctrico

ESQUEMA Nº 1

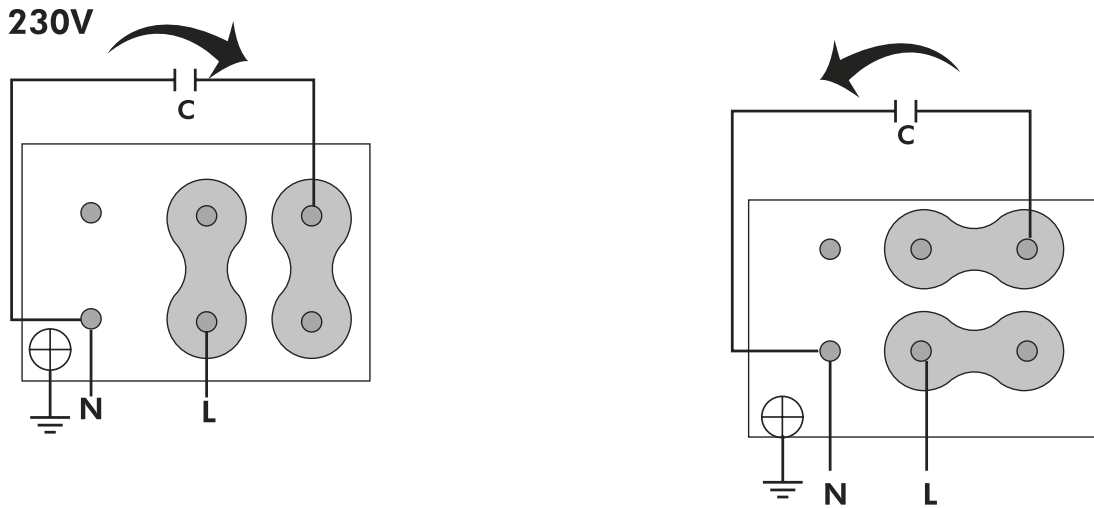

ESQUEMA Nº 2

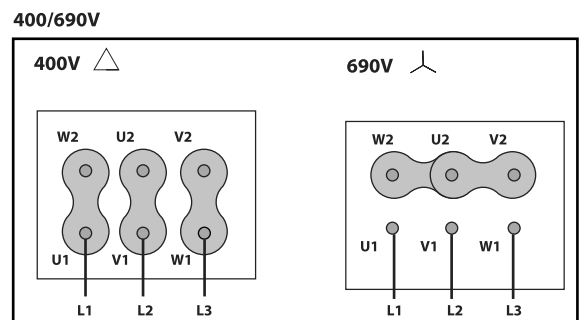
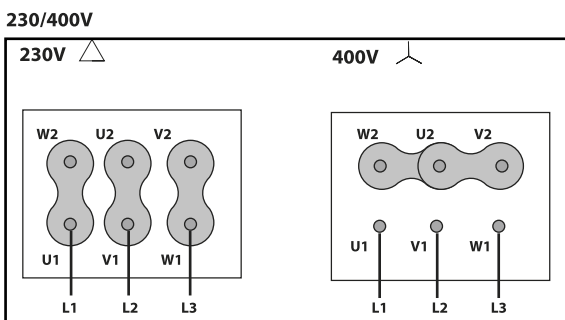

CURVA CARACTERÍSTICA

BOX HB 45 M4 (A0:6)

CAUDAL-PRESIÓN

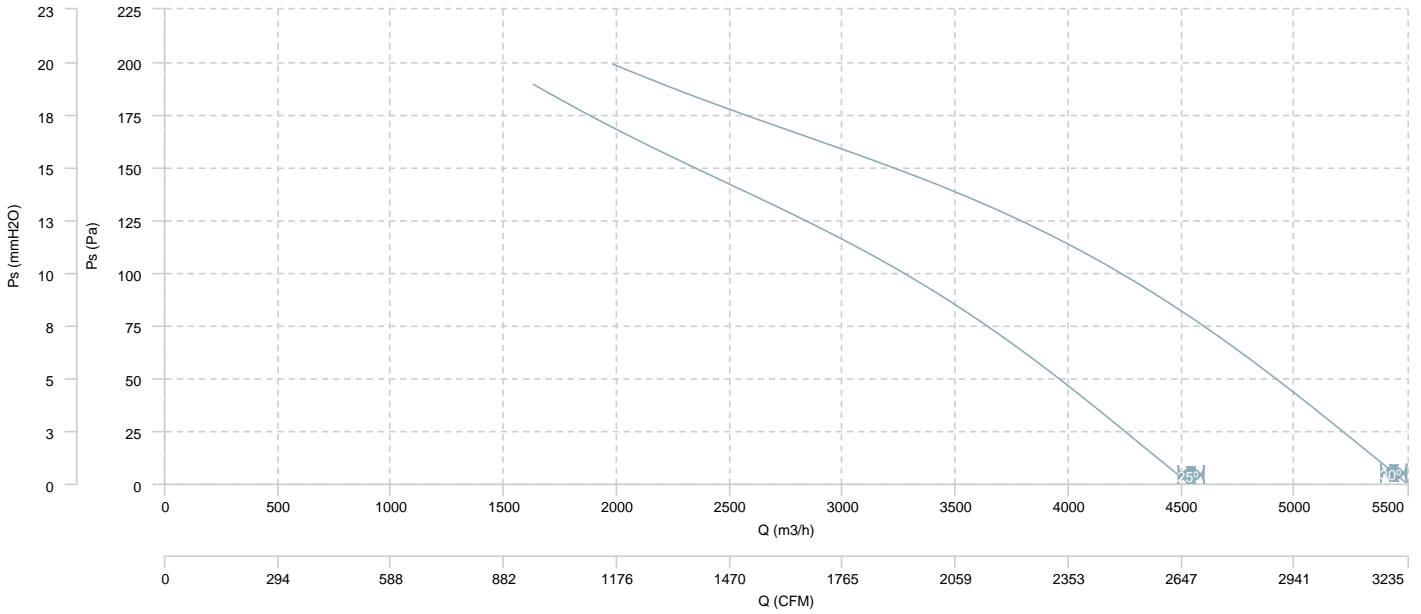

CAUDAL-POTENCIA MECÁNICA

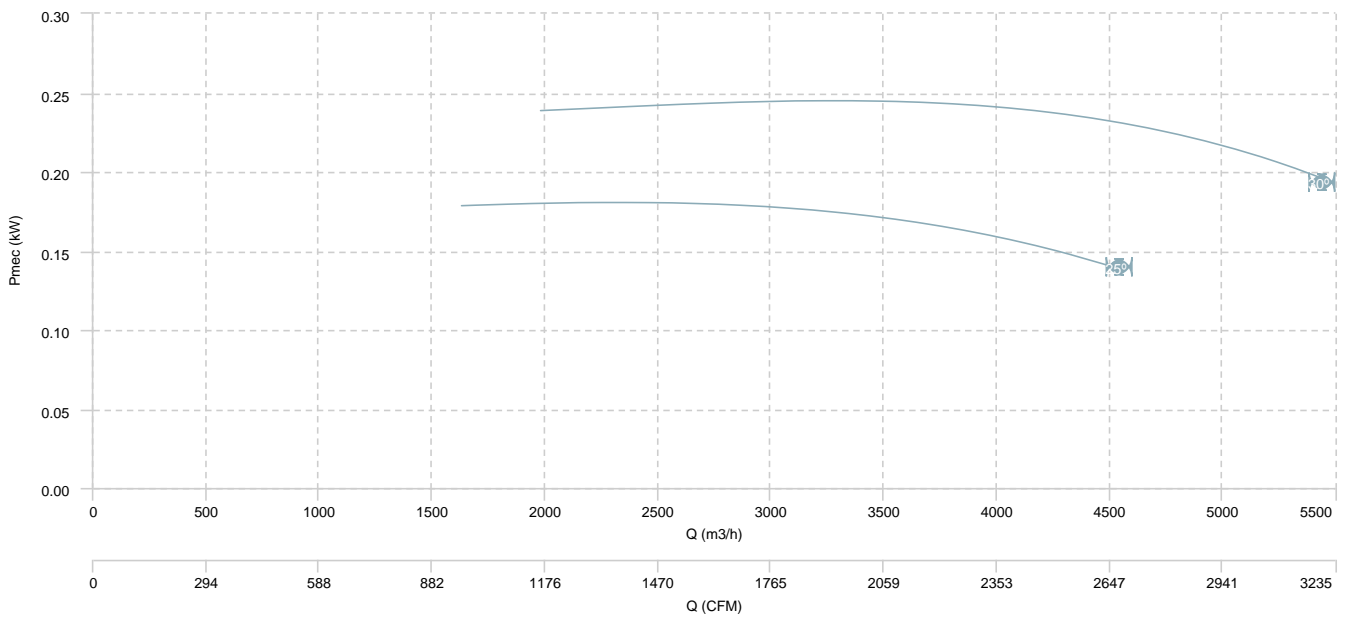

BOX HB 45 M6 (A0:6)

CAUDAL-PRESIÓN

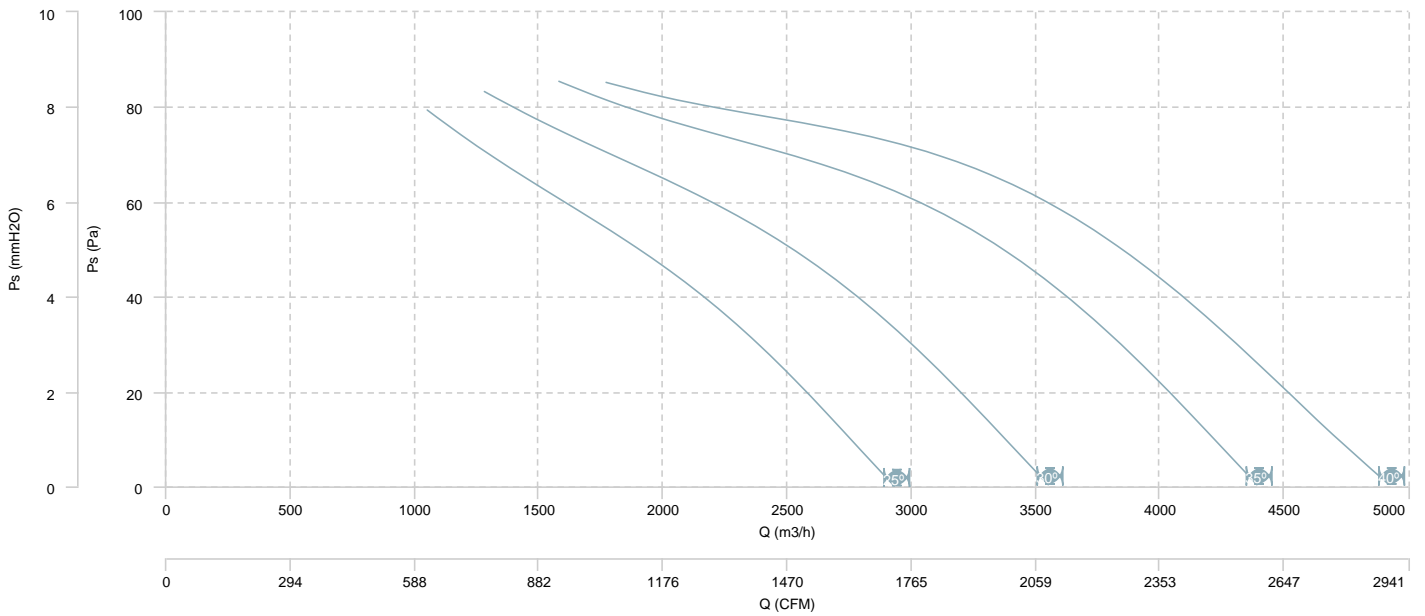

CAUDAL-POTENCIA MECÁNICA

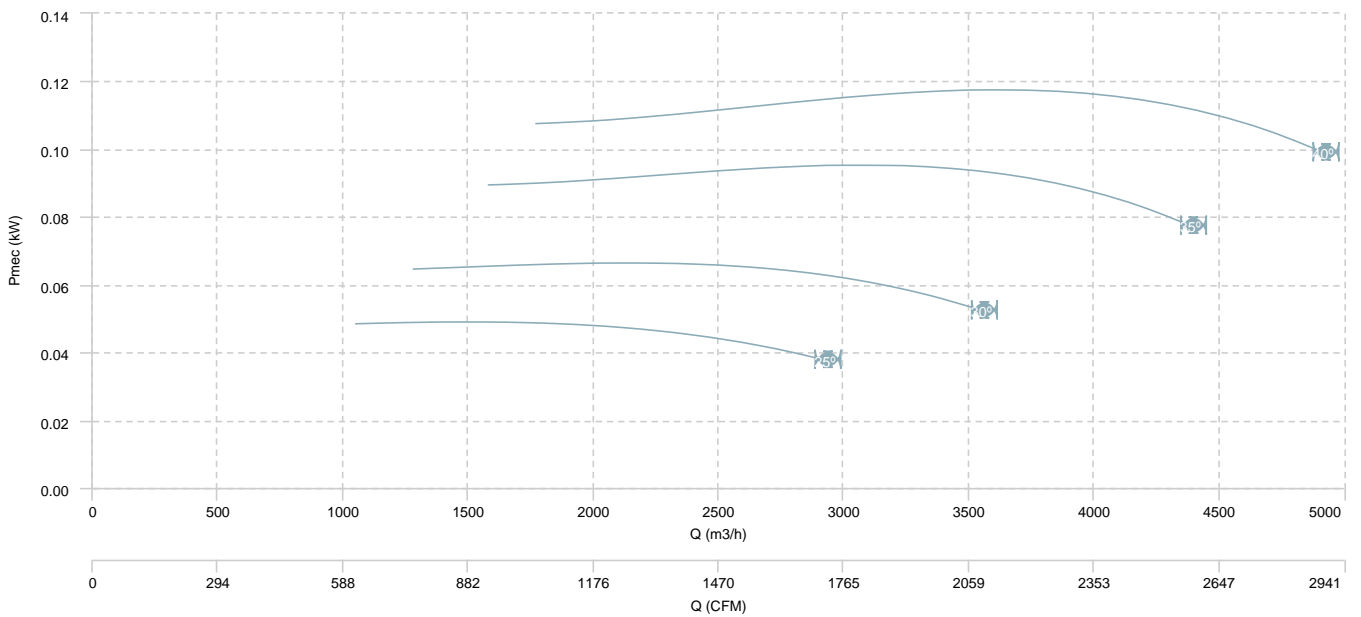

BOX HB 50 M4 (A0:6)

CAUDAL-PRESIÓN

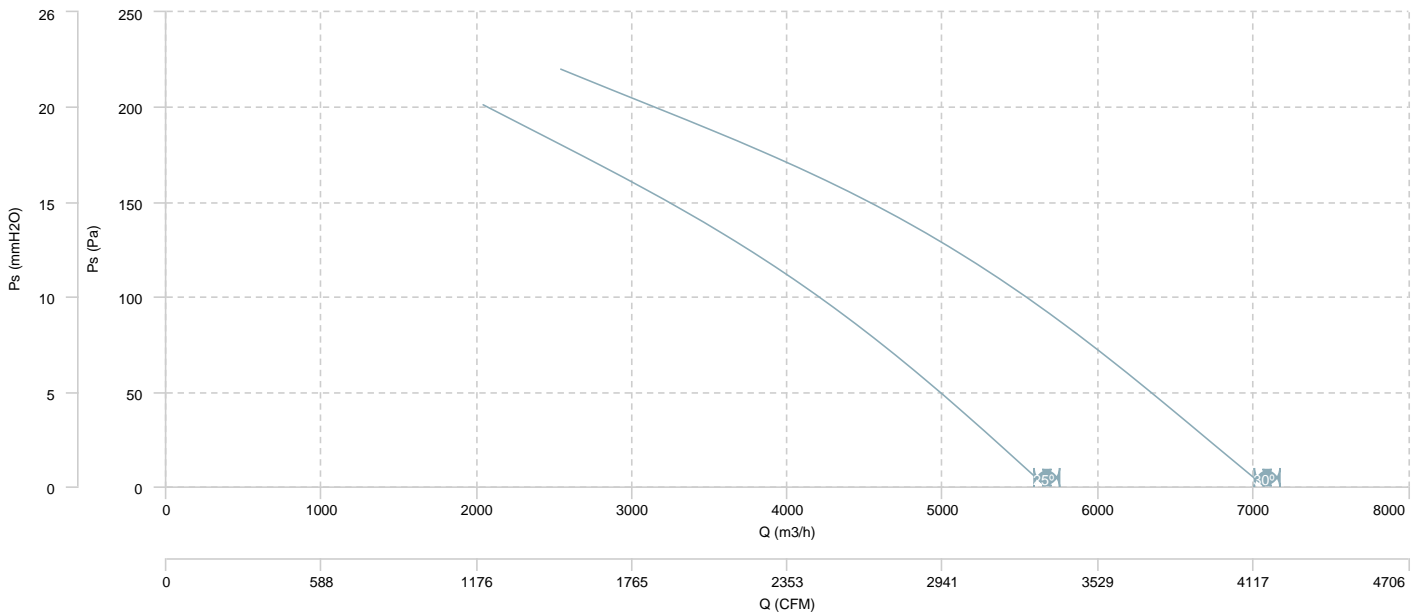

CAUDAL-POTENCIA MECÁNICA

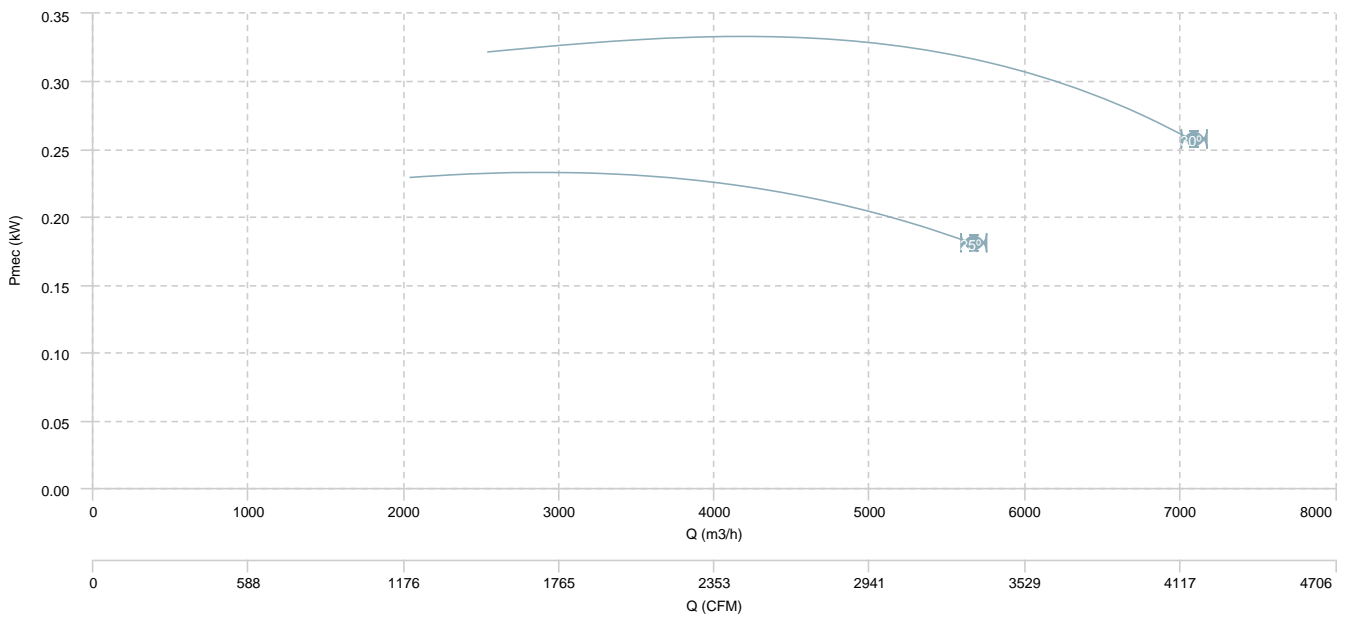

BOX HB 50 M6 (A0:6)

CAUDAL-PRESIÓN

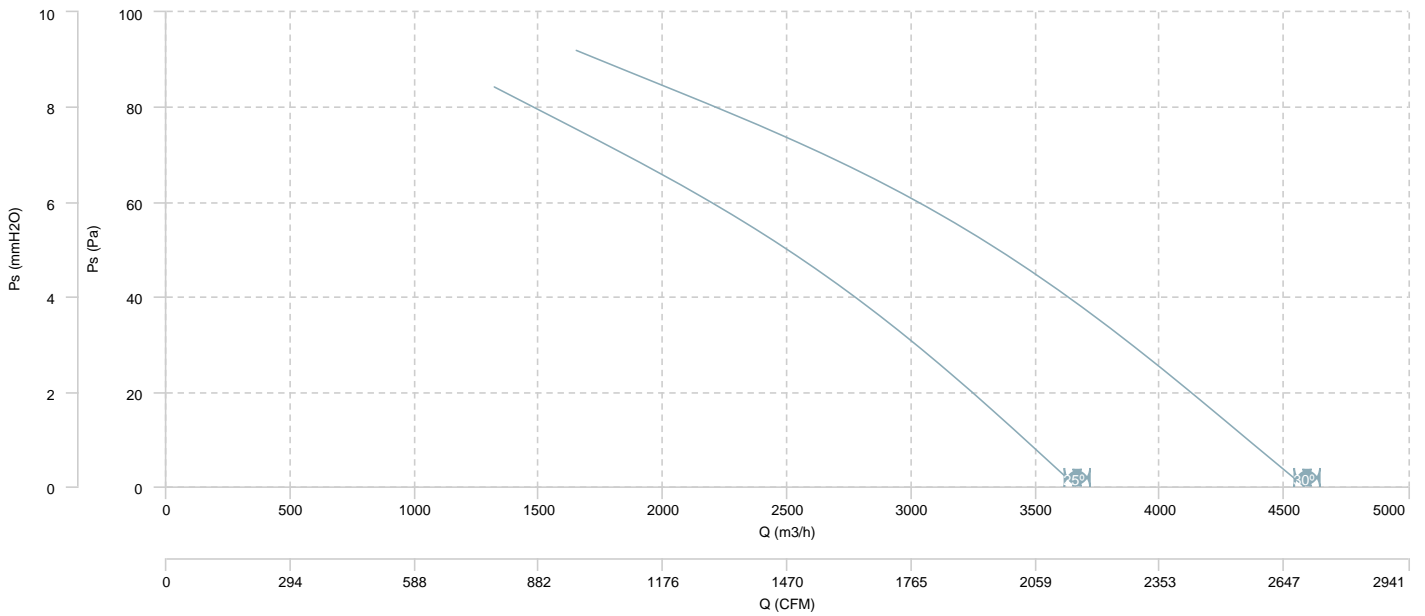

CAUDAL-POTENCIA MECÁNICA

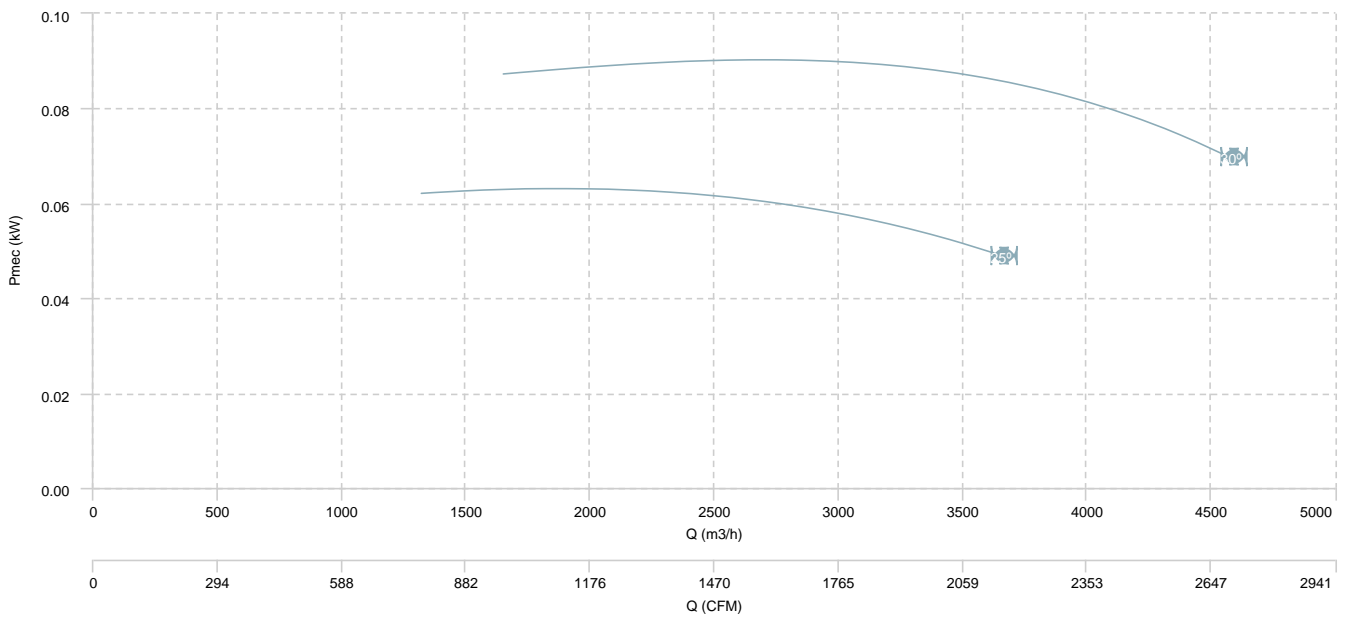

BOX HB 56 M4 (A2:6)

CAUDAL-PRESIÓN

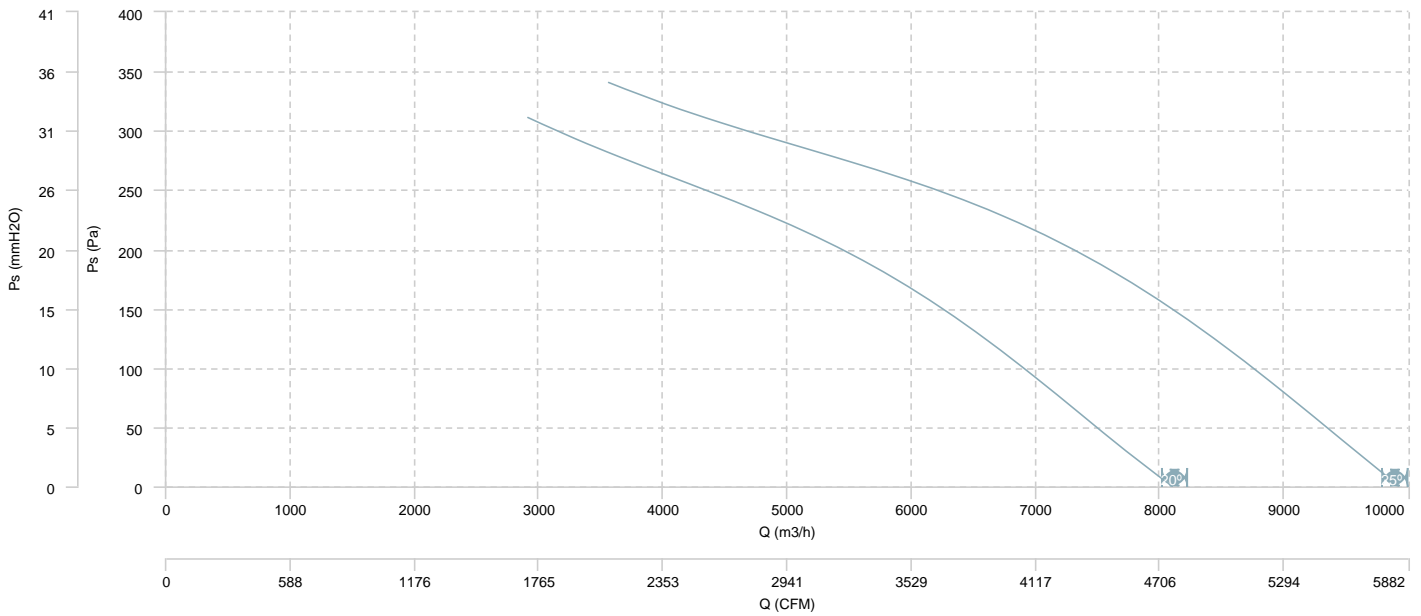

CAUDAL-POTENCIA MECÁNICA

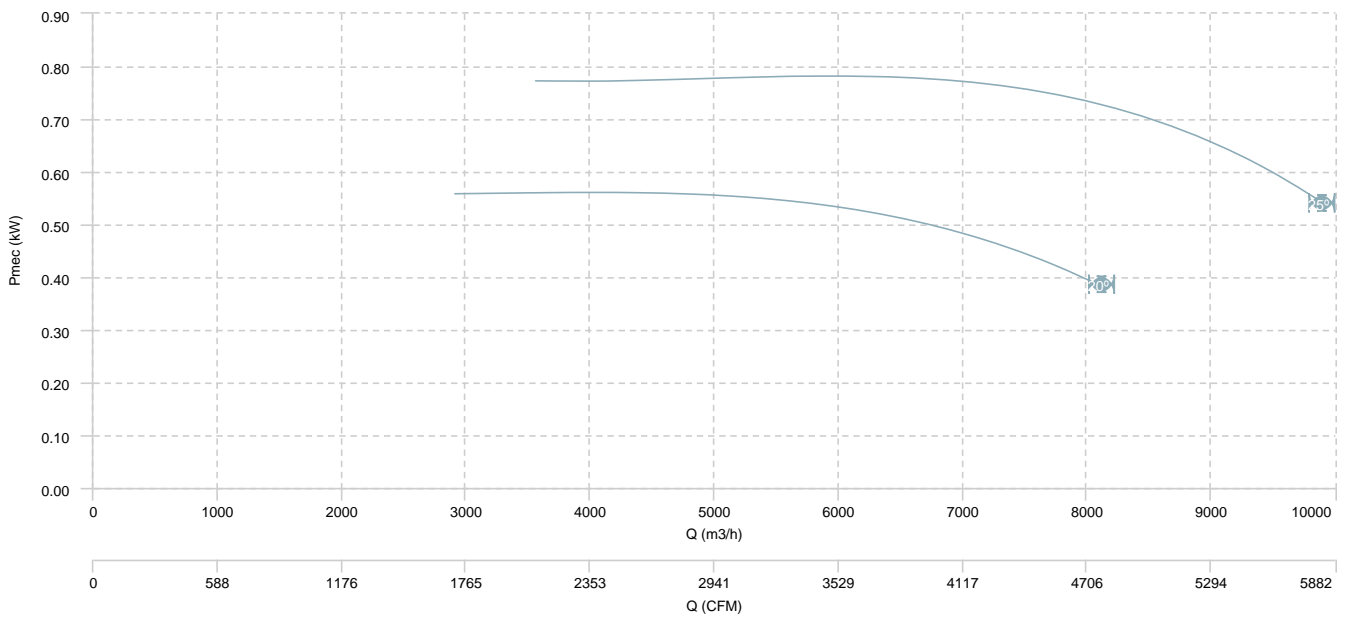

BOX HB 56 M4 (A2:9)

CAUDAL-PRESIÓN

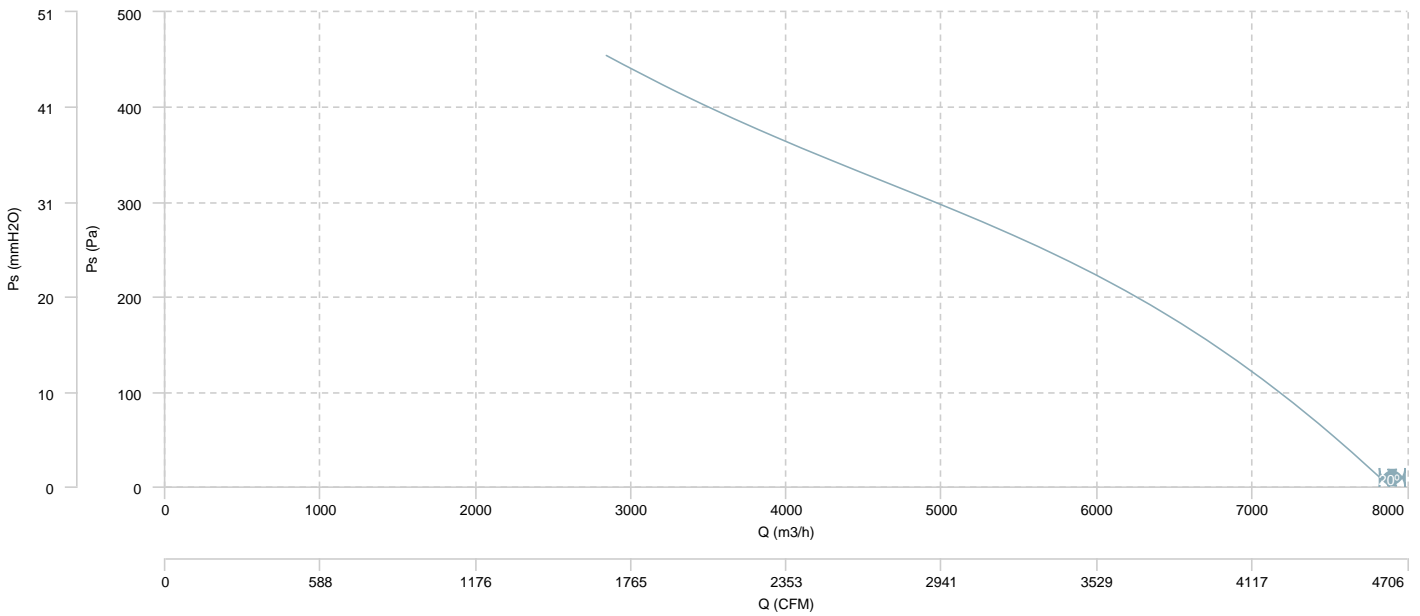

CAUDAL-POTENCIA MECÁNICA

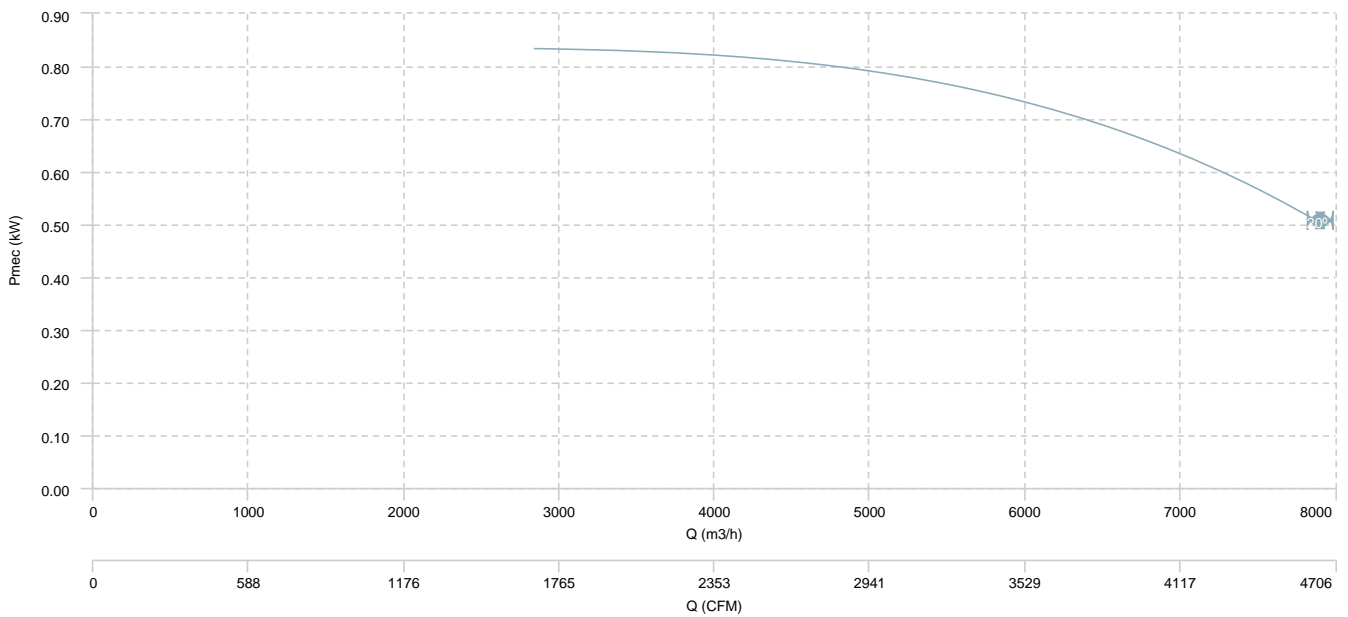

BOX HB 56 M4 (A5:6)

CAUDAL-PRESIÓN

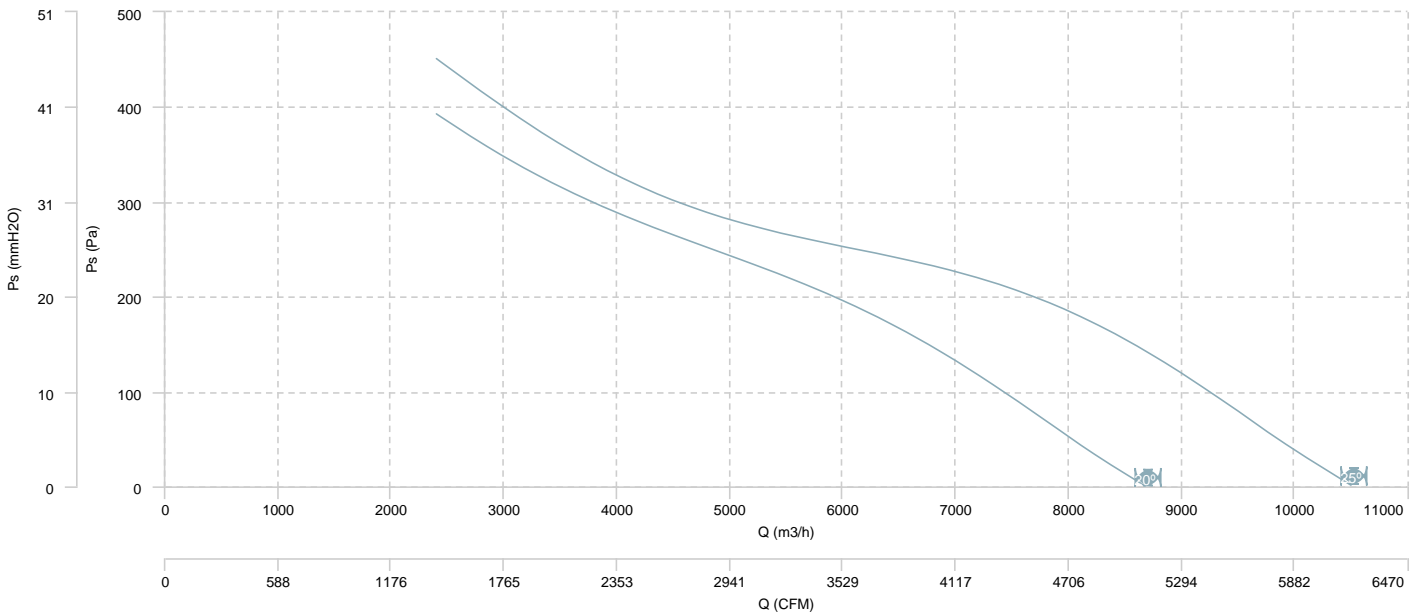

CAUDAL-POTENCIA MECÁNICA

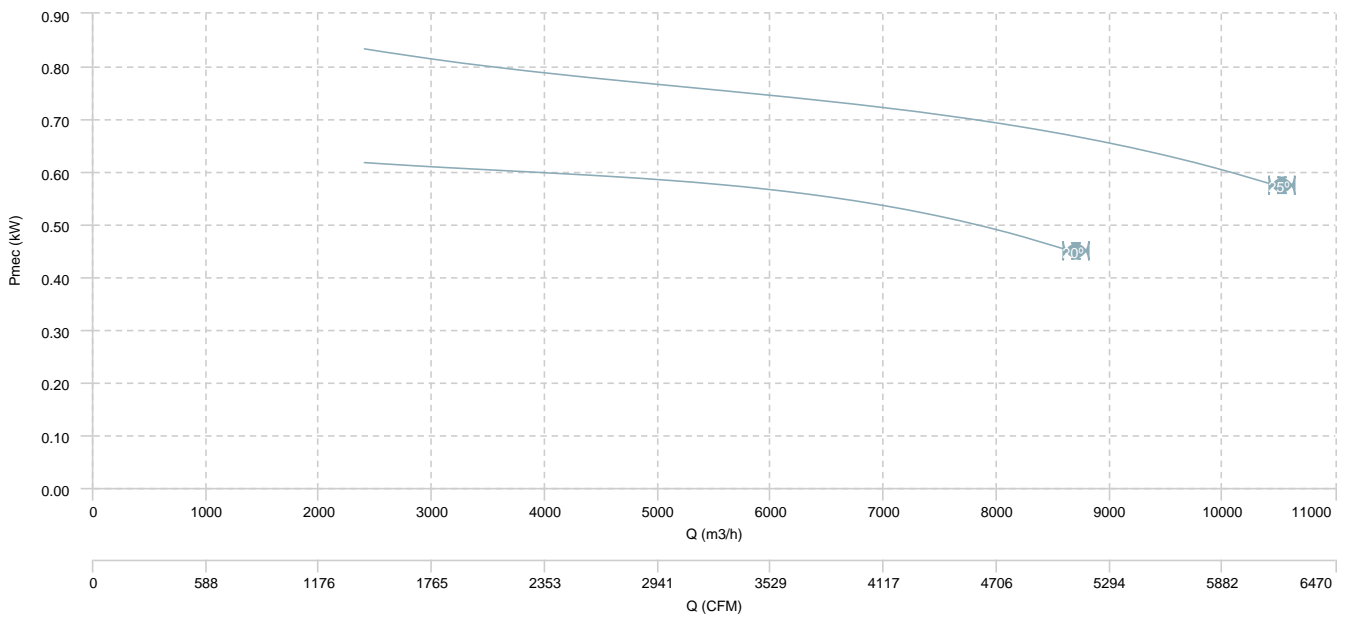

BOX HB 56 M6 (A2:6)

CAUDAL-PRESIÓN

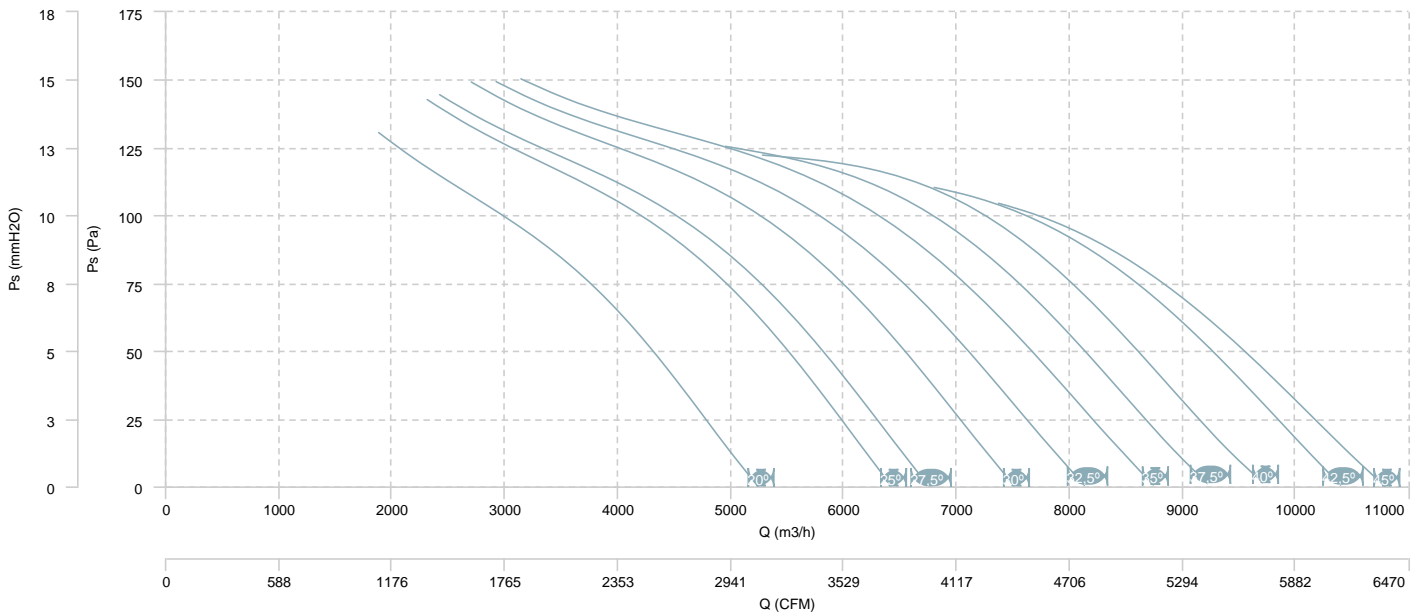

CAUDAL-POTENCIA MECÁNICA

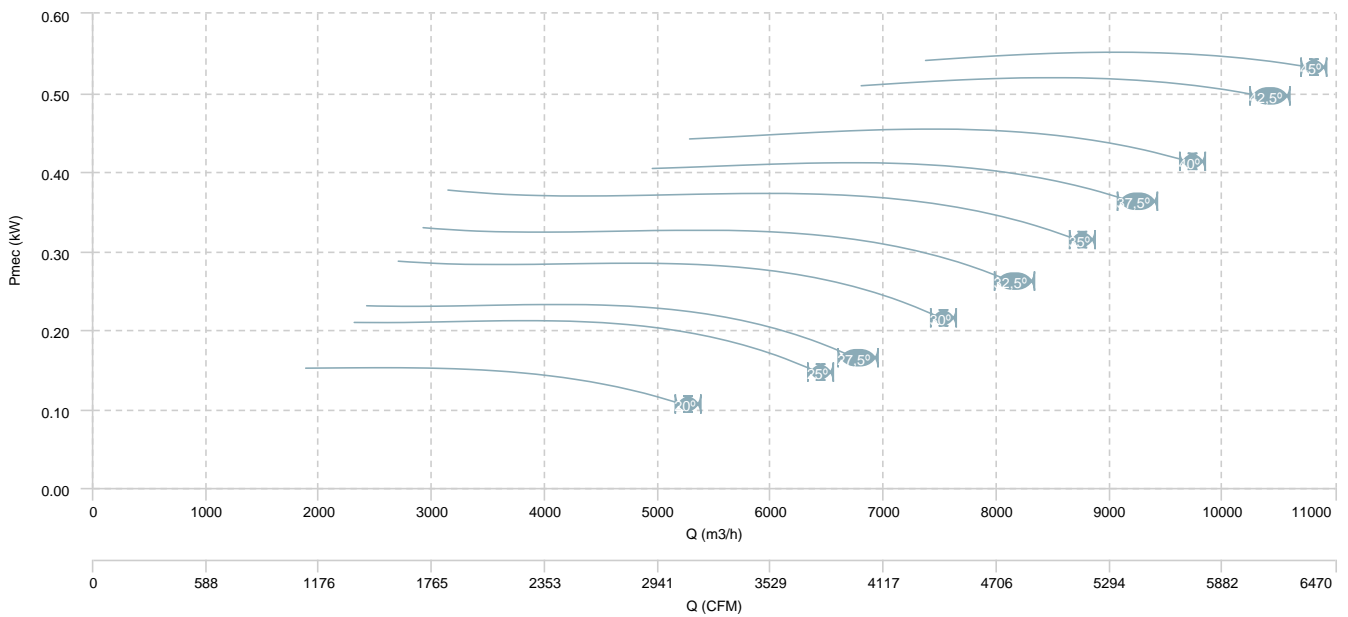

BOX HB 56 M6 (A2:9)

CAUDAL-PRESIÓN

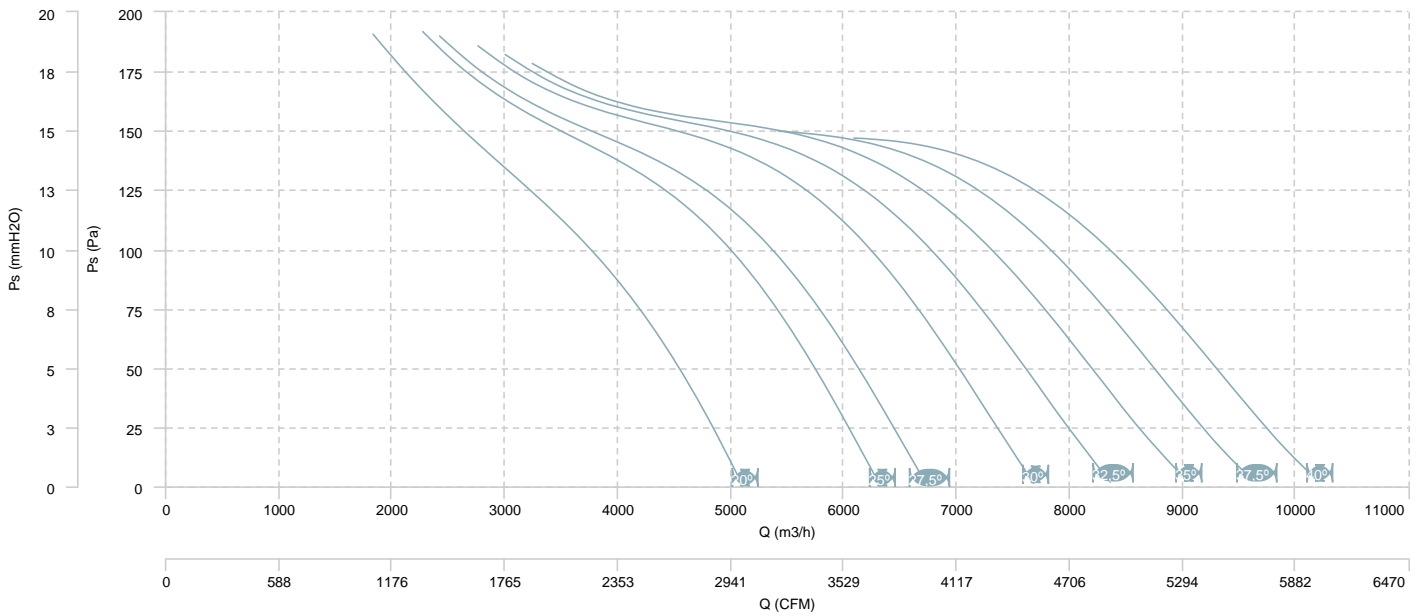

CAUDAL-POTENCIA MECÁNICA

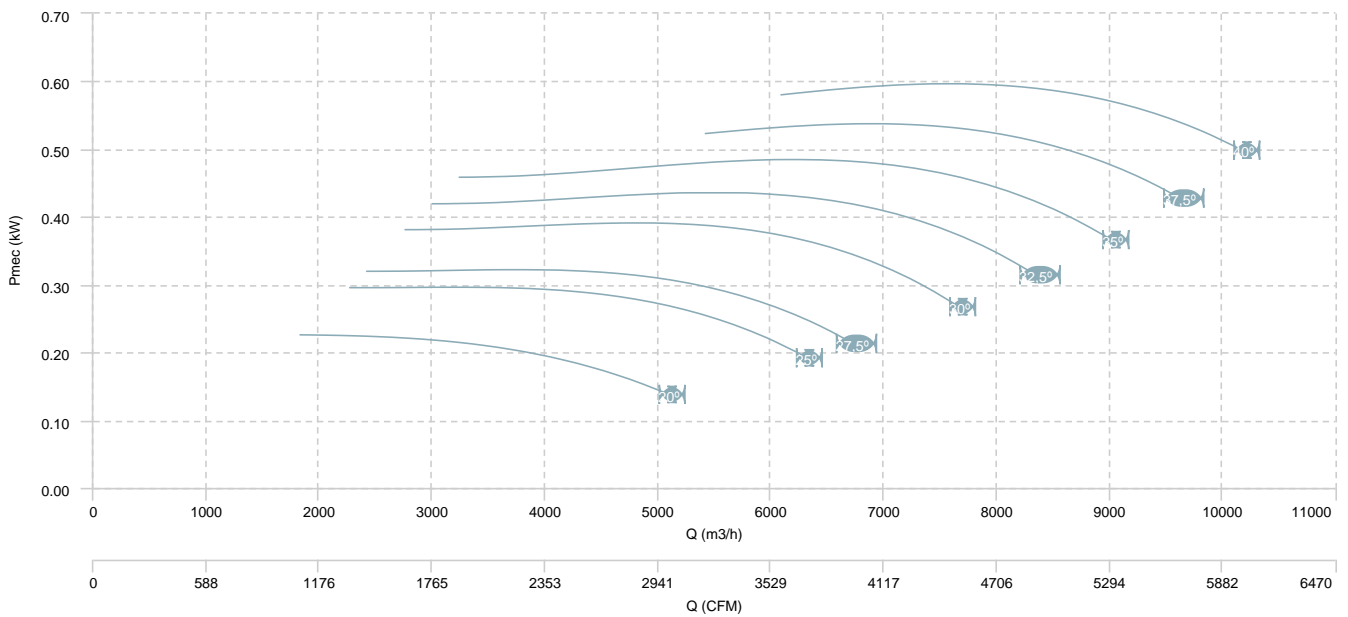

BOX HB 56 M6 (A5:6)

CAUDAL-PRESIÓN

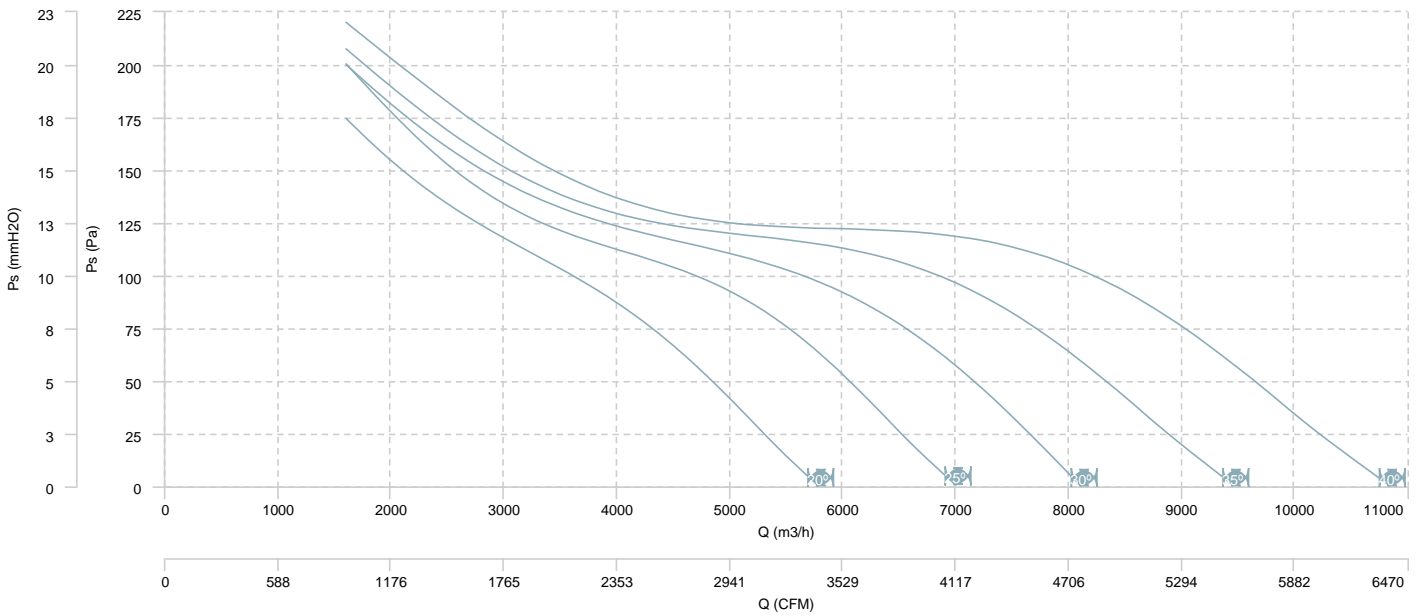

CAUDAL-POTENCIA MECÁNICA

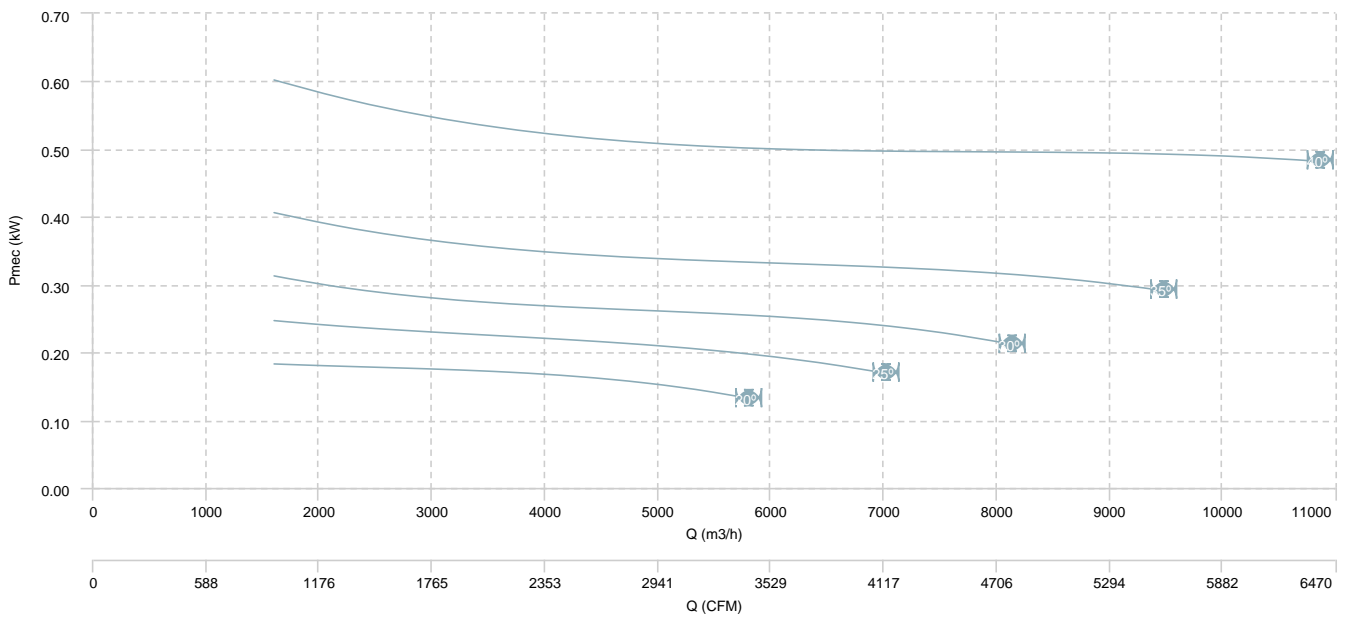

BOX HB 45 T4 (A0:6)

CAUDAL-PRESIÓN

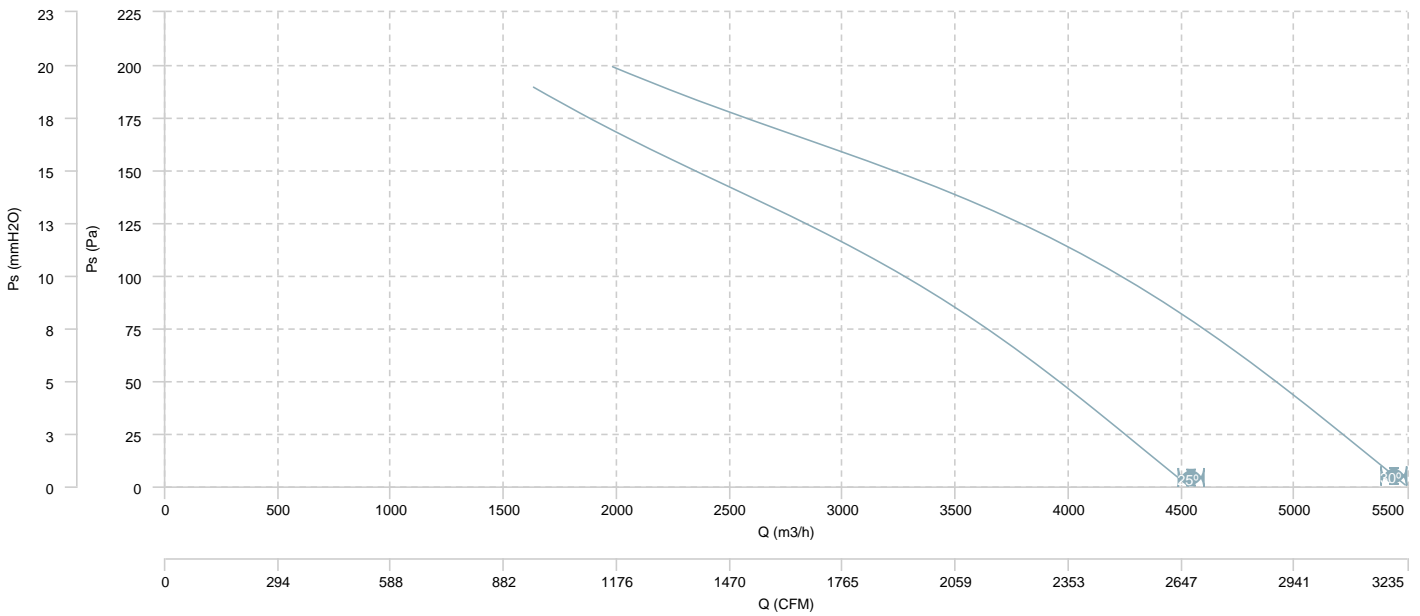

CAUDAL-POTENCIA MECÁNICA

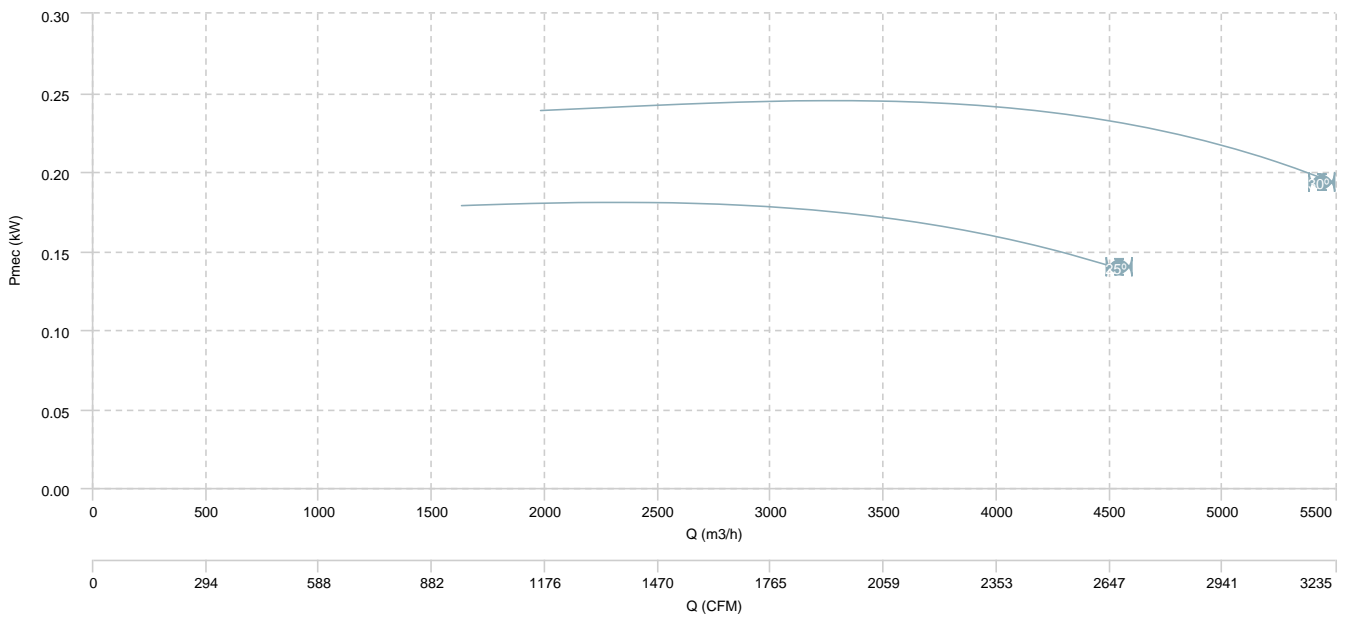

BOX HB 45 T6 (A0:6)

CAUDAL-PRESIÓN

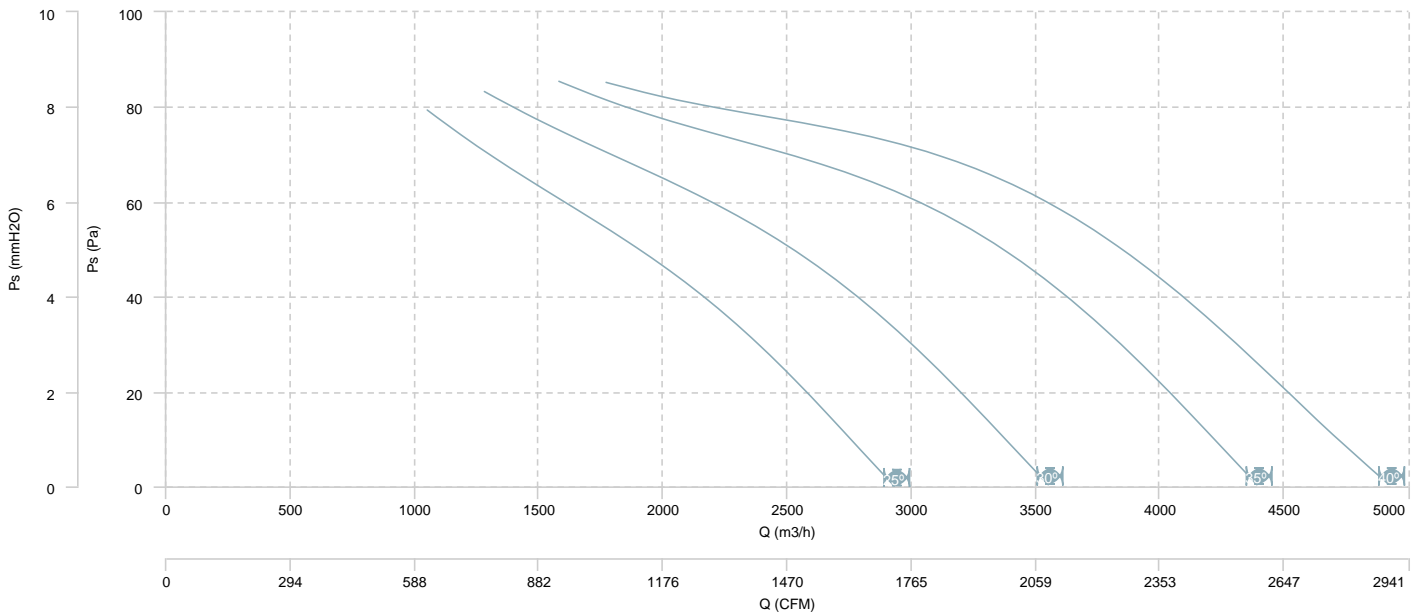

CAUDAL-POTENCIA MECÁNICA

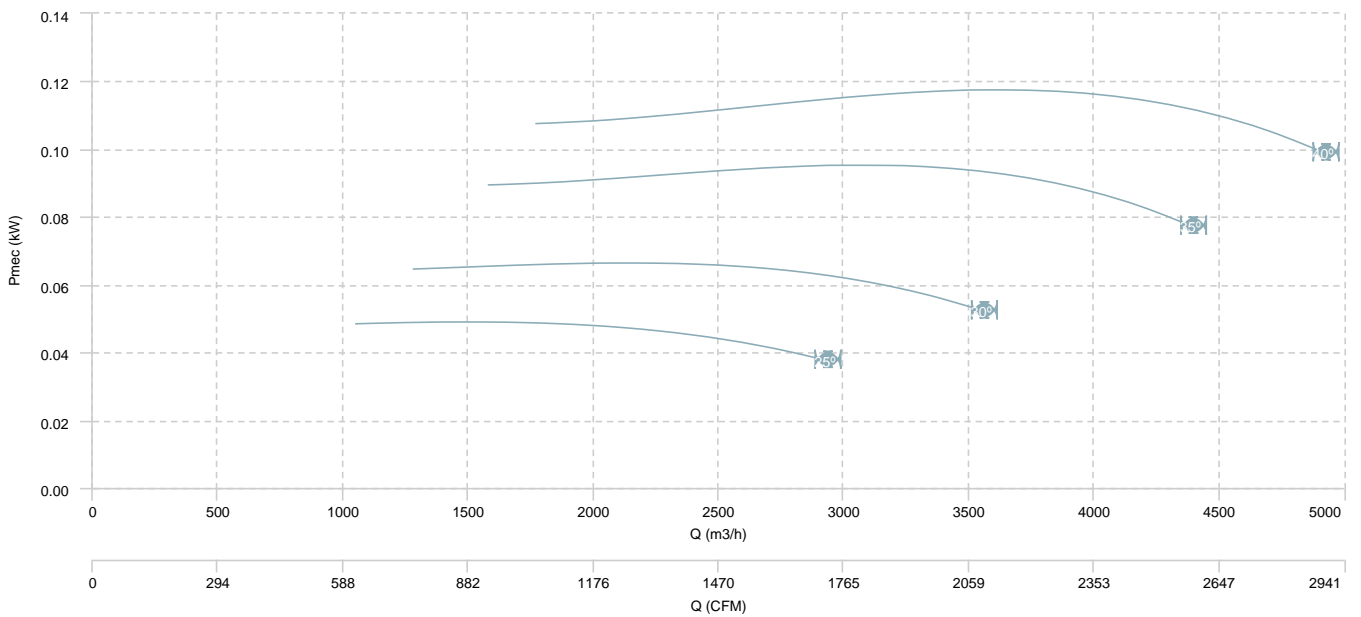

BOX HB 50 T4 (A0:6)

CAUDAL-PRESIÓN

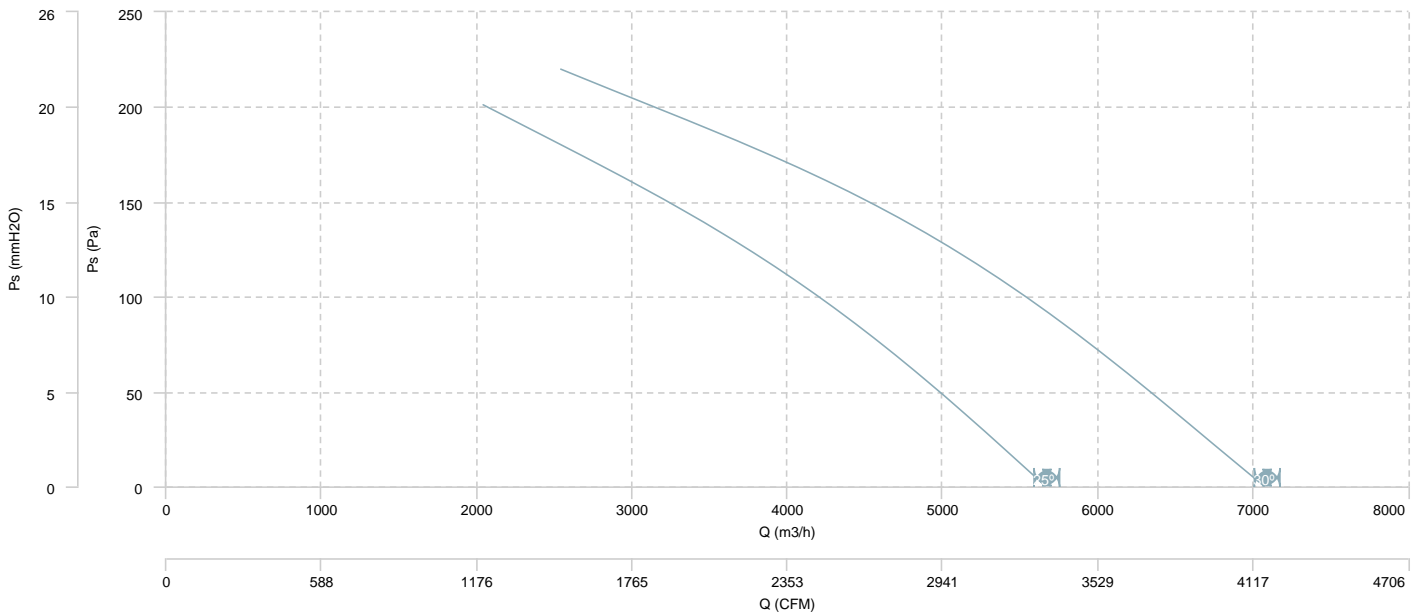

CAUDAL-POTENCIA MECÁNICA

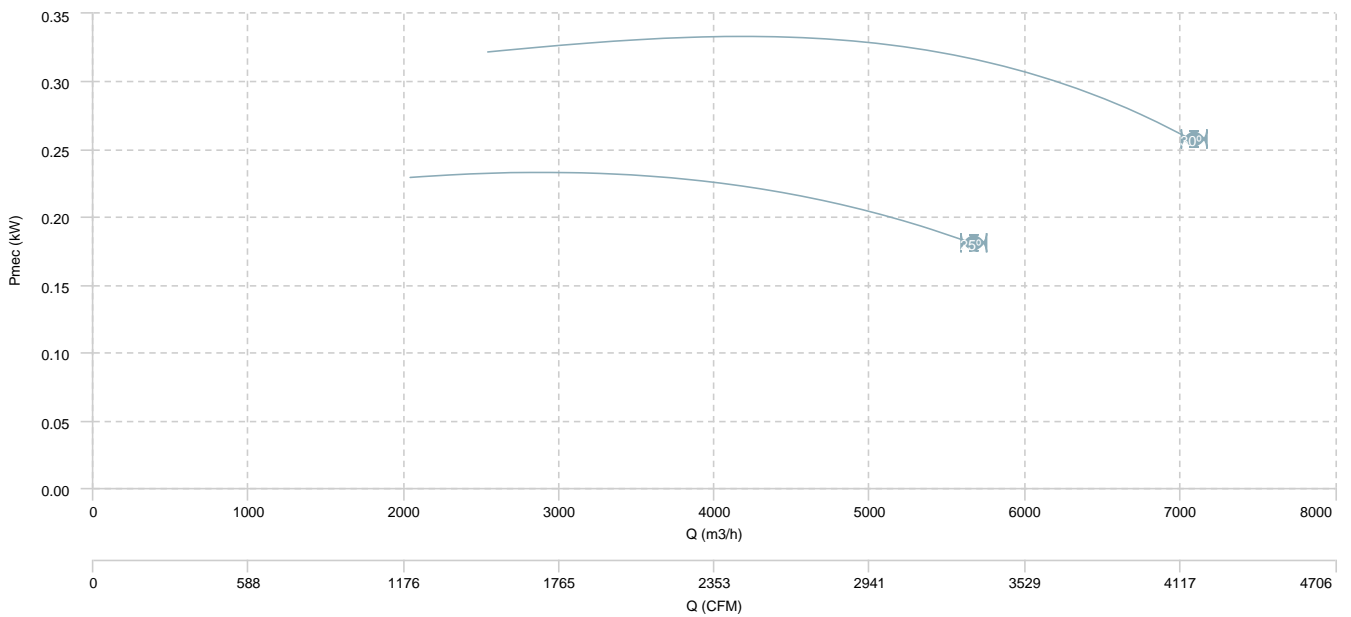

BOX HB 50 T6 (A0:6)

CAUDAL-PRESIÓN

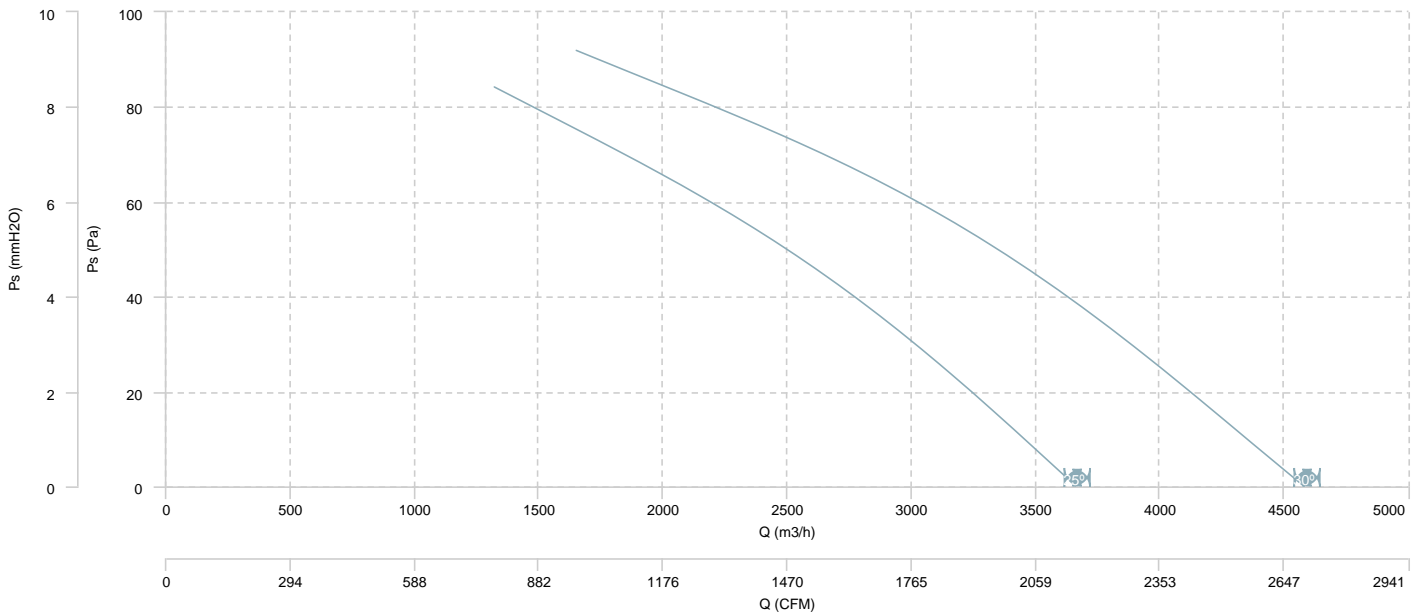

CAUDAL-POTENCIA MECÁNICA

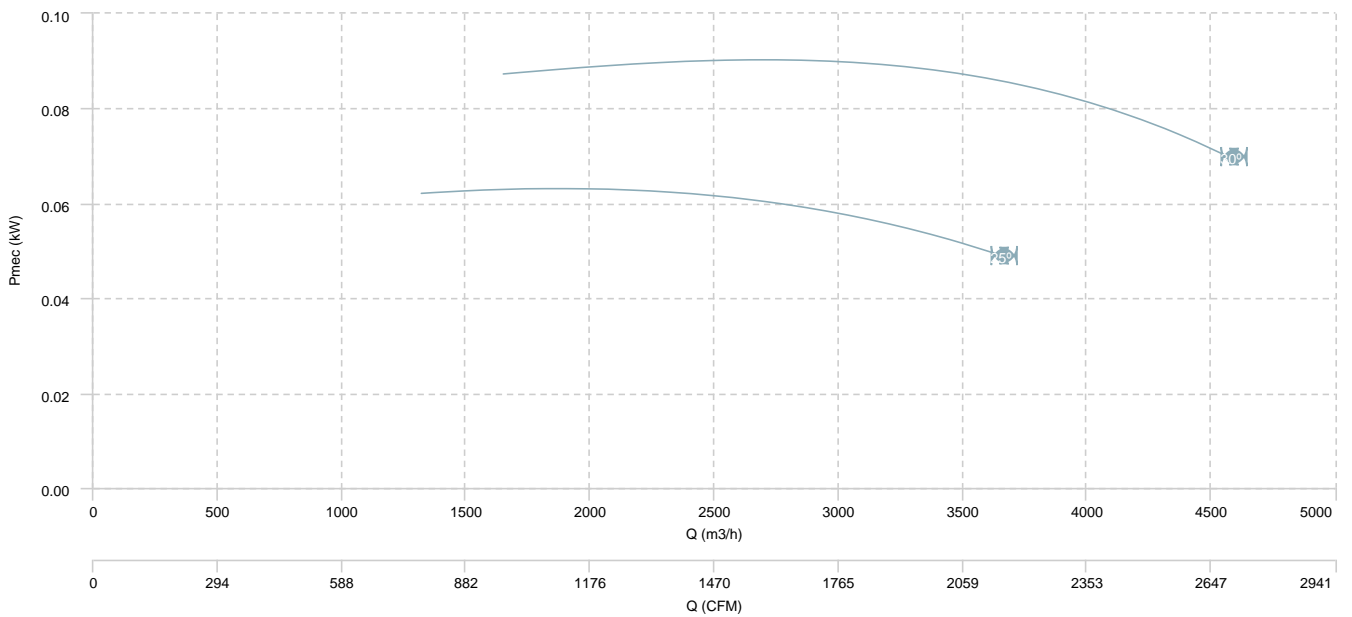

BOX HB 56 T4 (A2:6)

CAUDAL-PRESIÓN

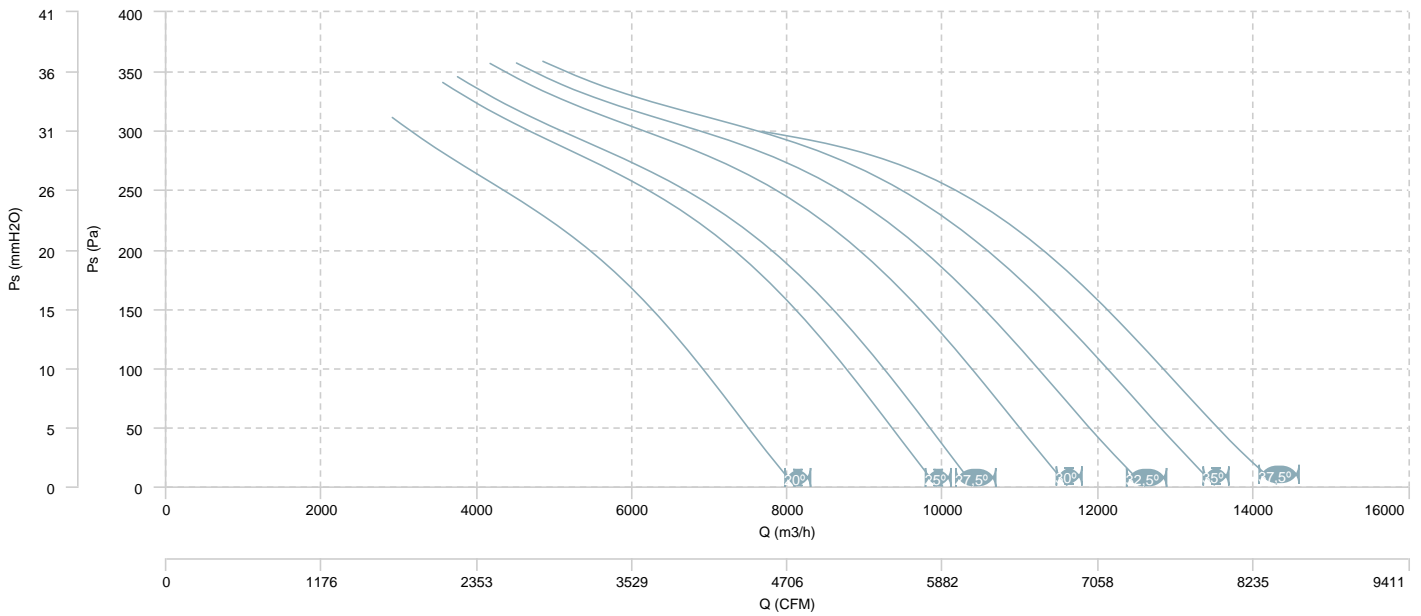

CAUDAL-POTENCIA MECÁNICA

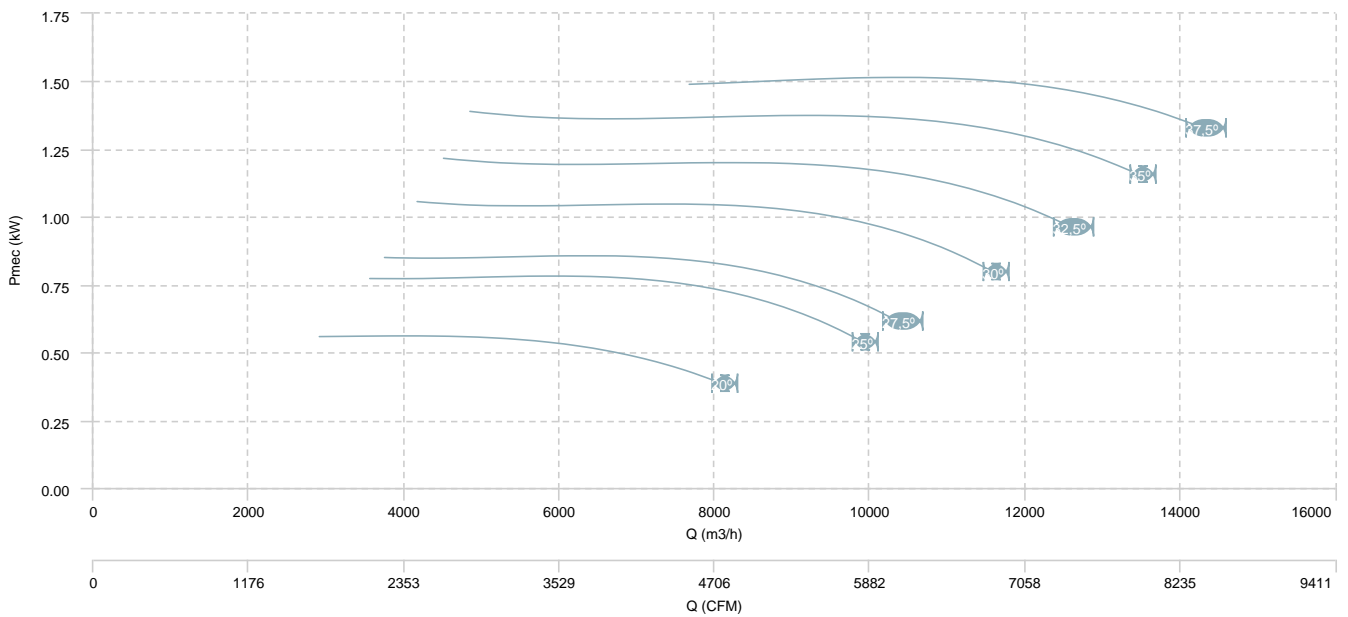

BOX HB 56 T4 (A2:9)

CAUDAL-PRESIÓN

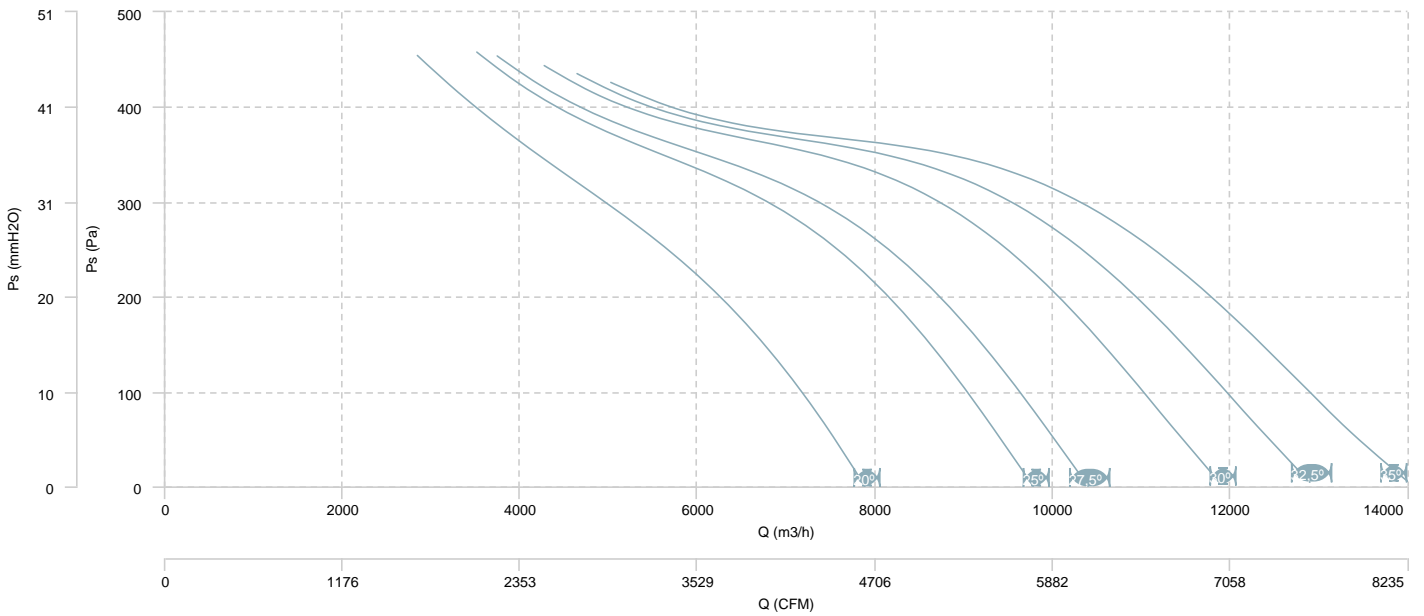

CAUDAL-POTENCIA MECÁNICA

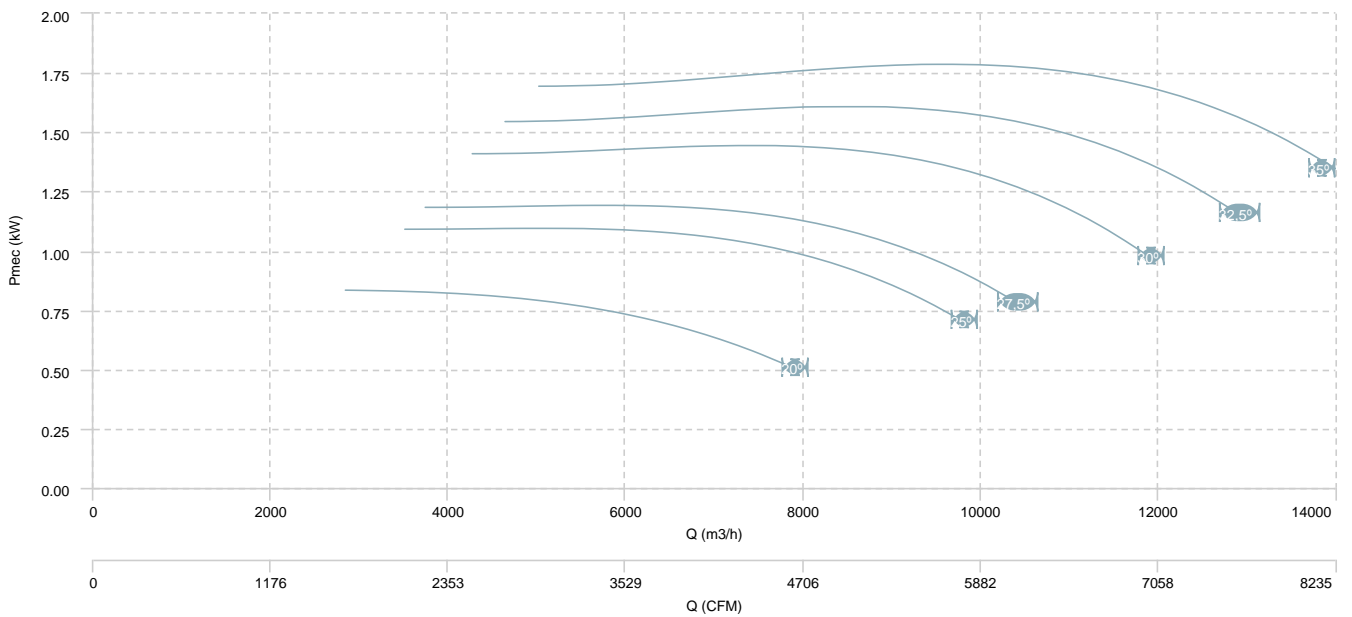

BOX HB 56 T4 (A5:6)

CAUDAL-PRESIÓN

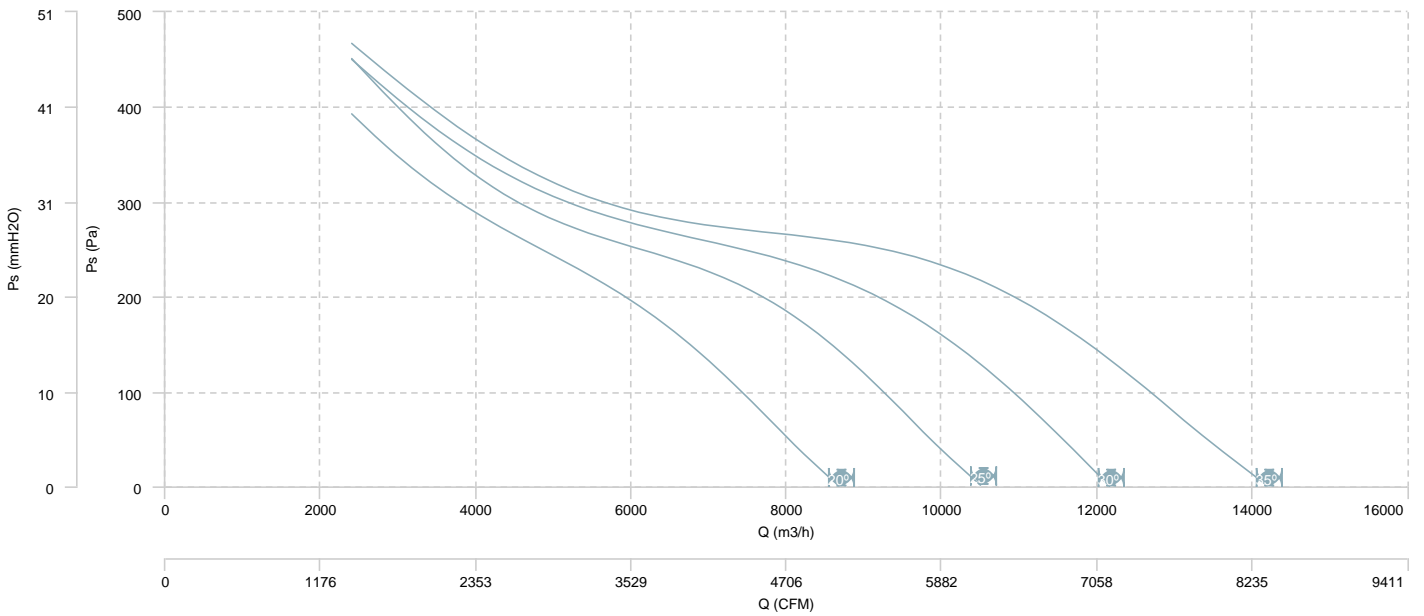

CAUDAL-POTENCIA MECÁNICA

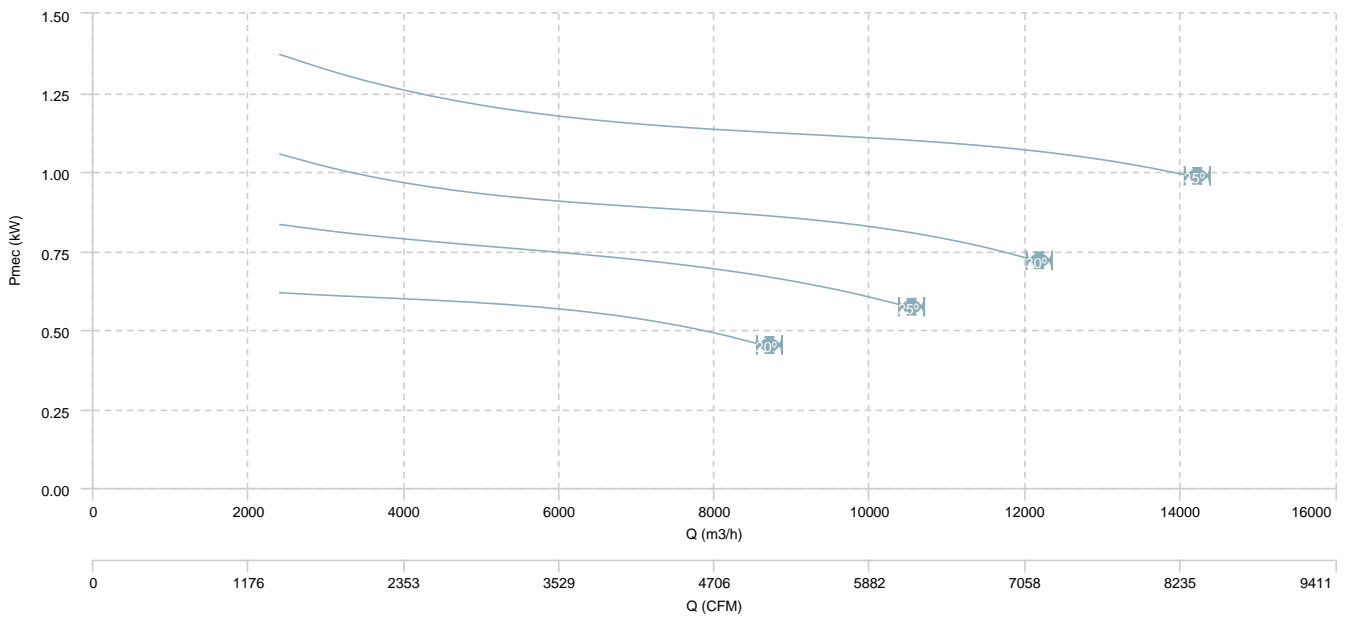

BOX HB 56 T6 (A2:6)

CAUDAL-PRESIÓN

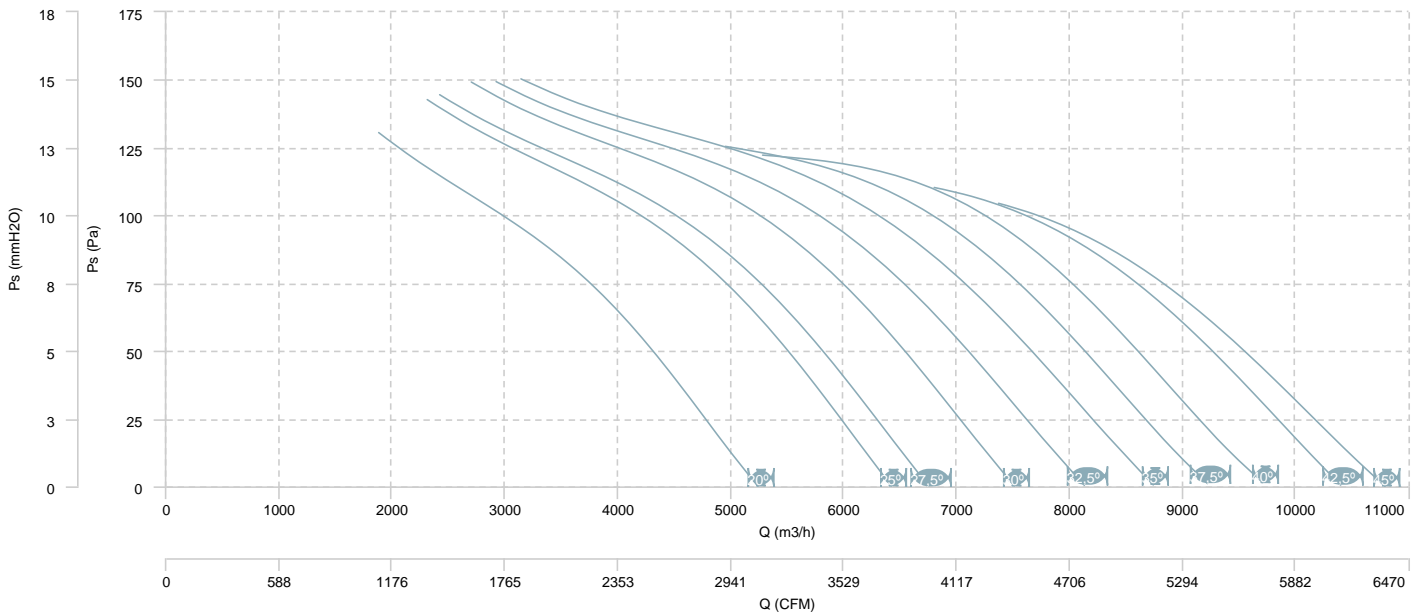

CAUDAL-POTENCIA MECÁNICA

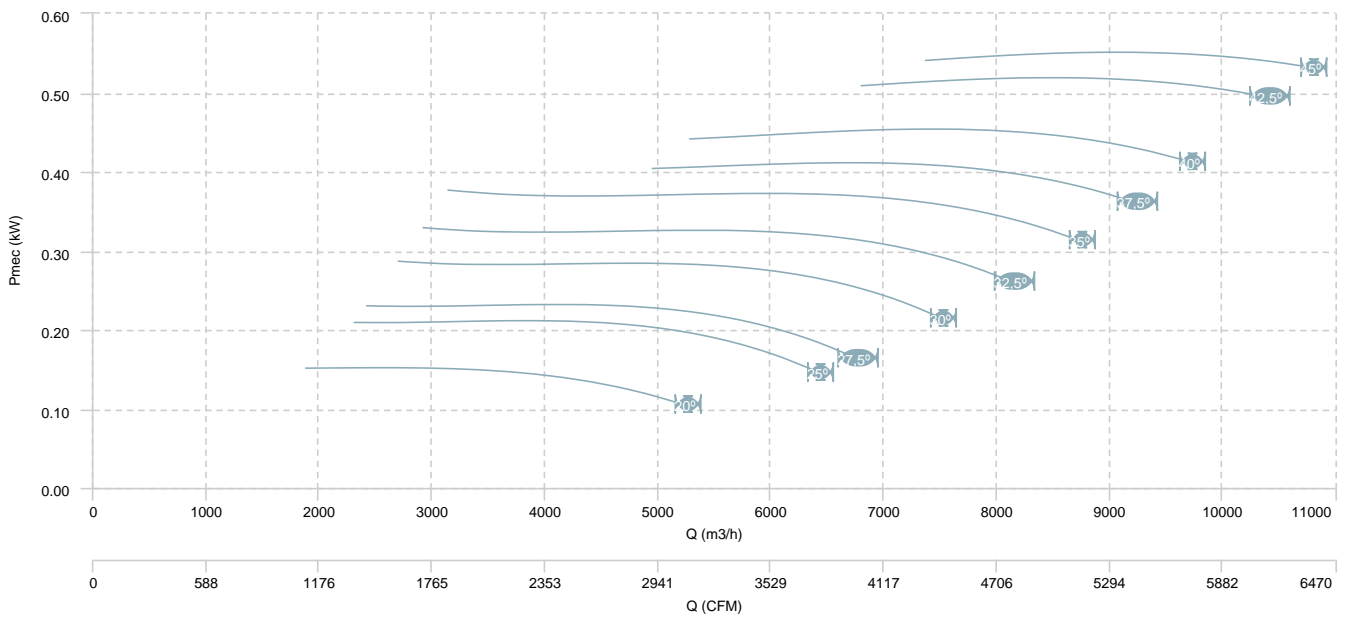

BOX HB 56 T6 (A2:9)

CAUDAL-PRESIÓN

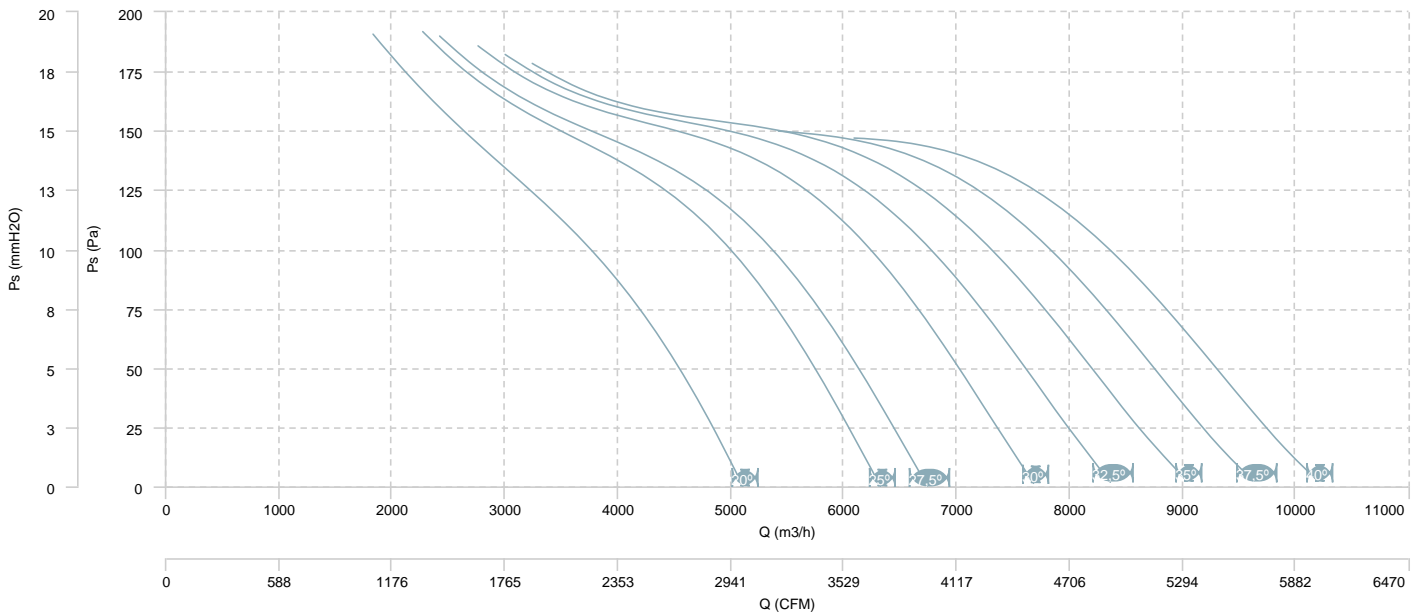

CAUDAL-POTENCIA MECÁNICA

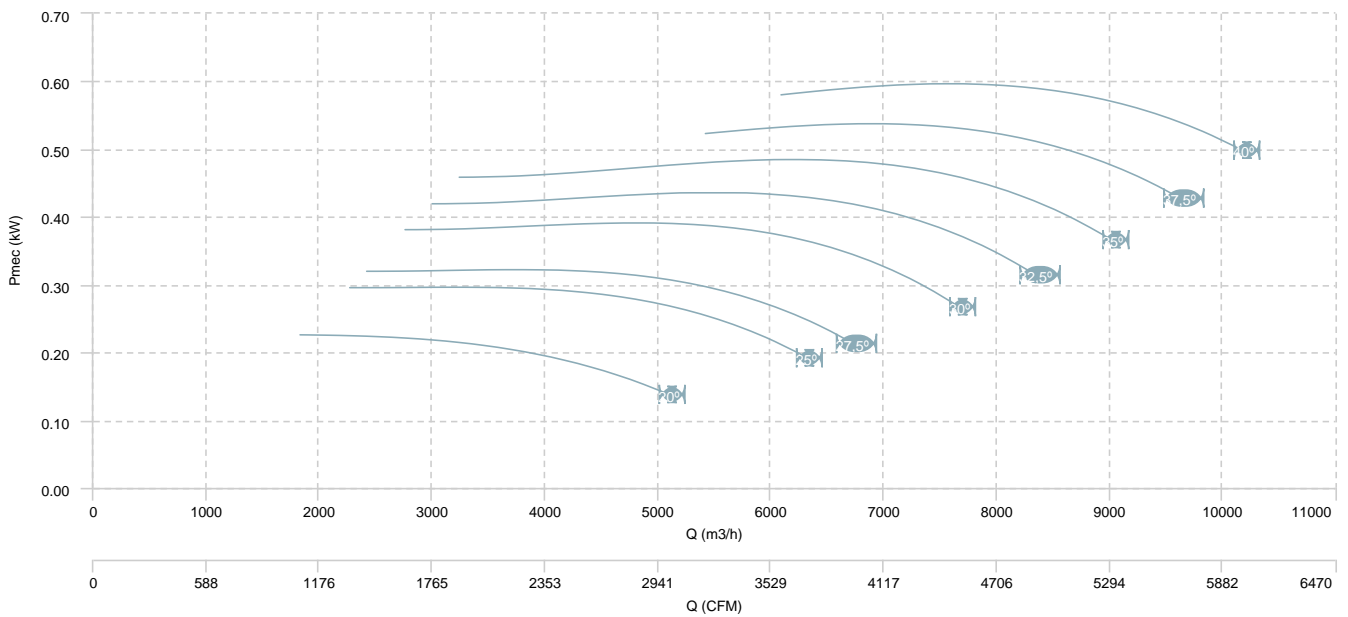

BOX HB 56 T6 (A5:6)

CAUDAL-PRESIÓN

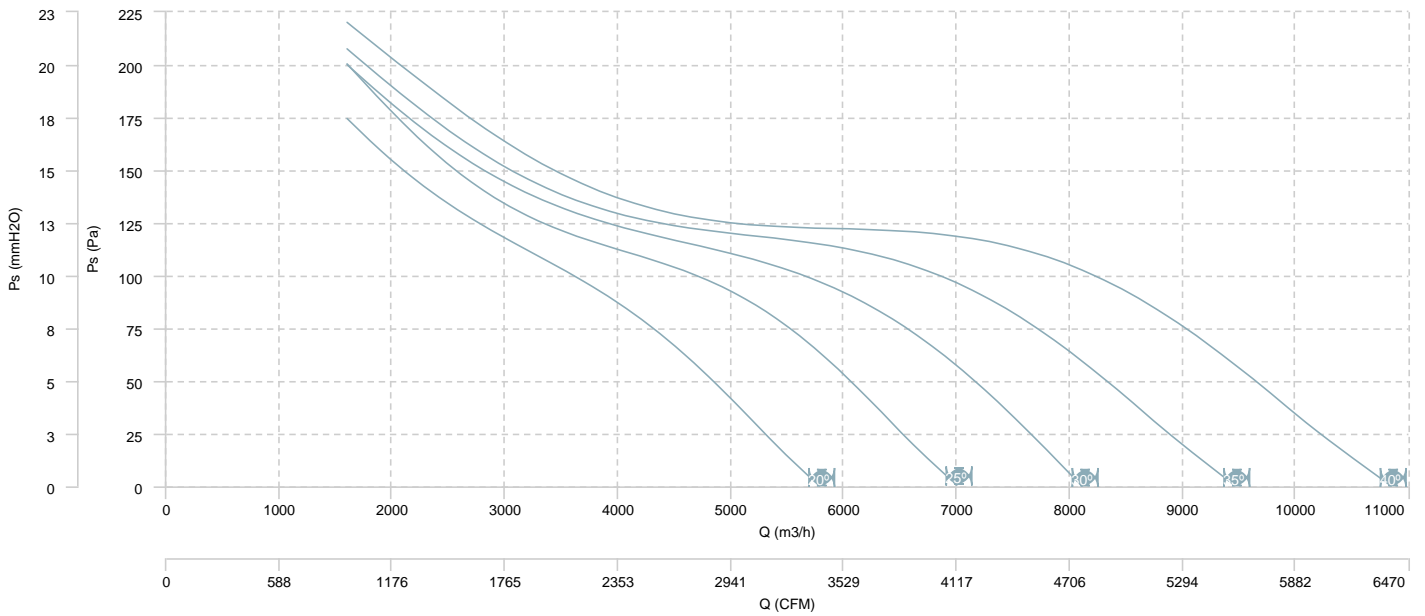

CAUDAL-POTENCIA MECÁNICA

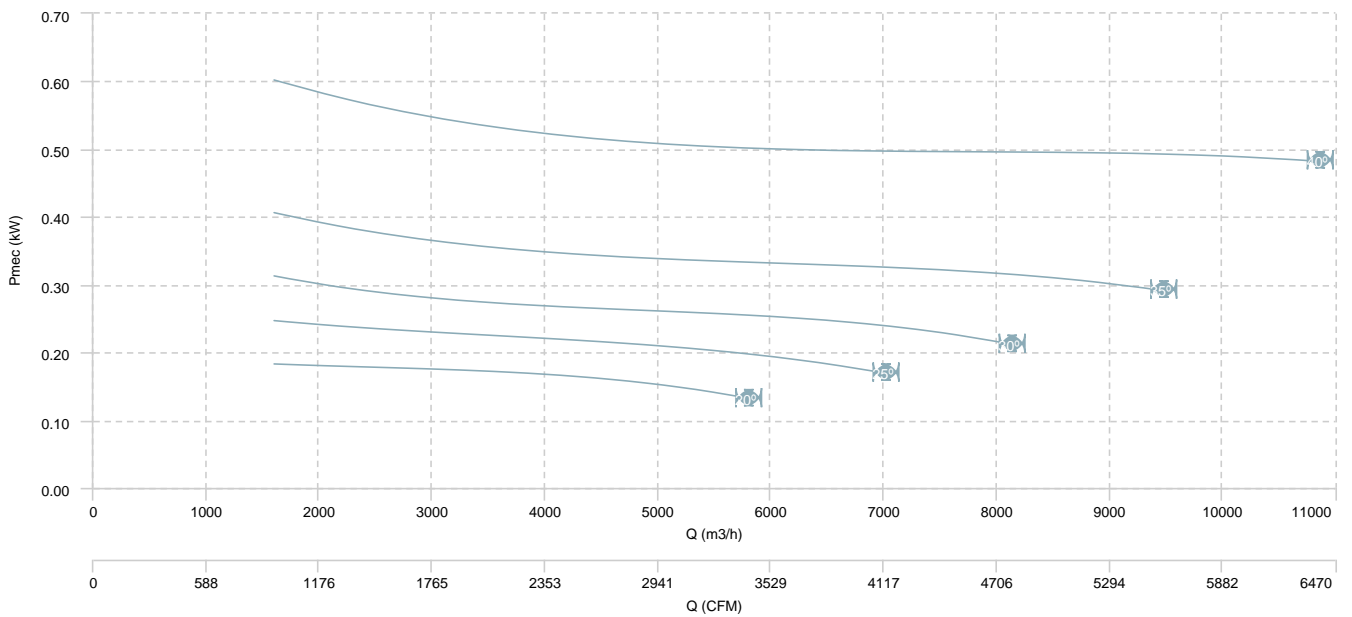

BOX HB 63 T4 (A5:6)

CAUDAL-PRESIÓN

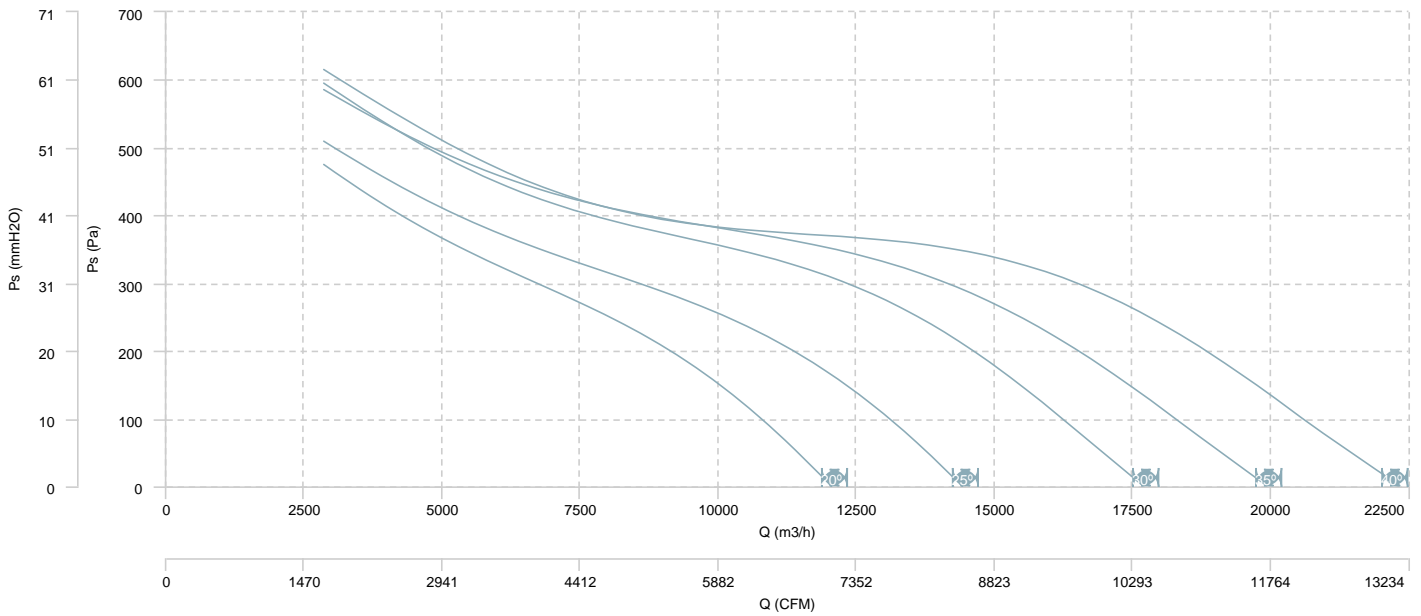

CAUDAL-POTENCIA MECÁNICA

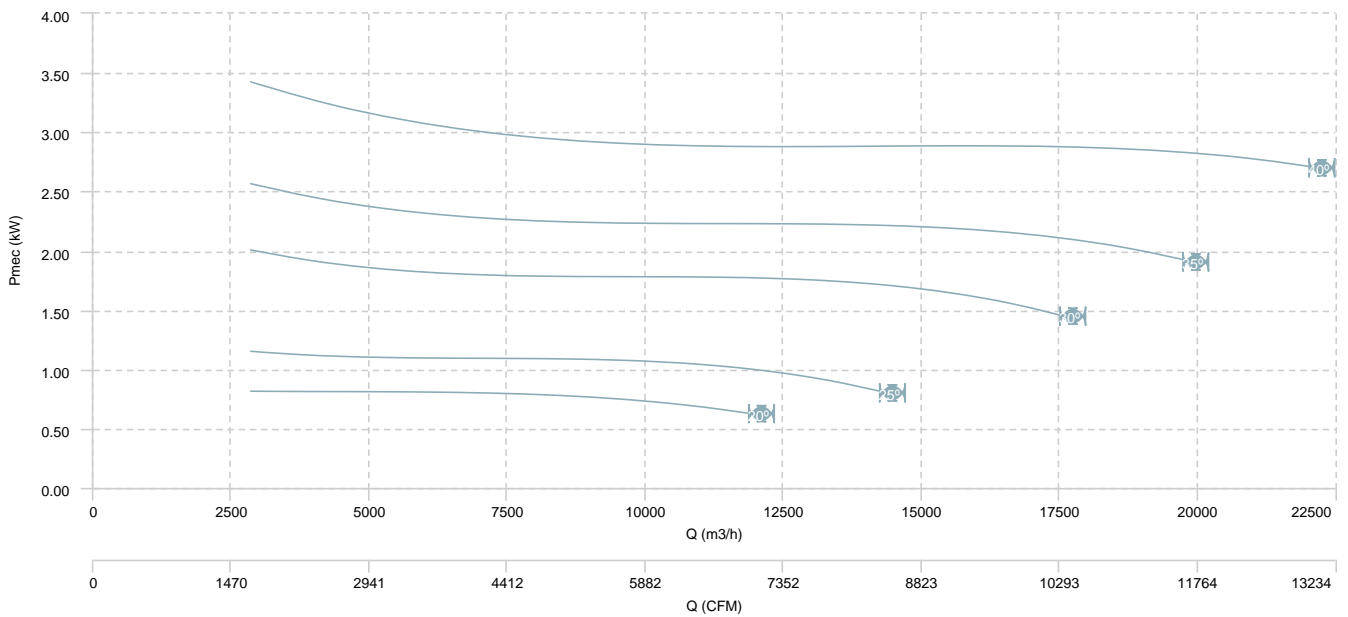

BOX HB 63 T4 (A2:6)

CAUDAL-PRESIÓN

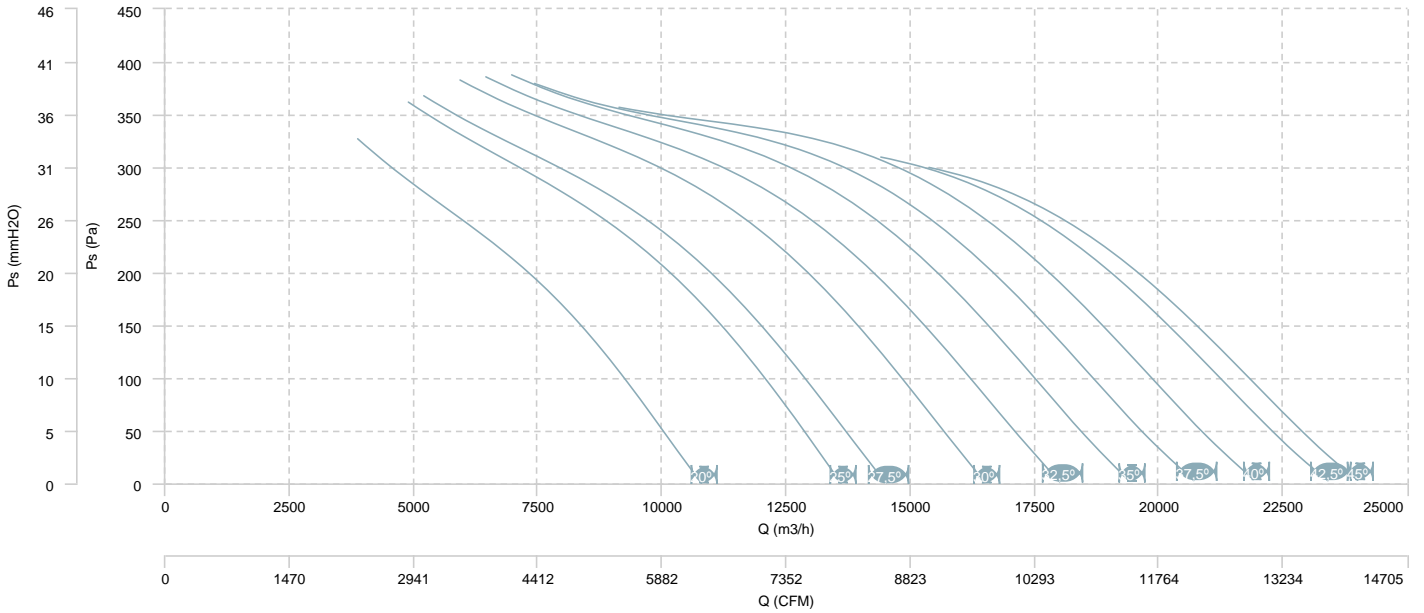

CAUDAL-POTENCIA MECÁNICA

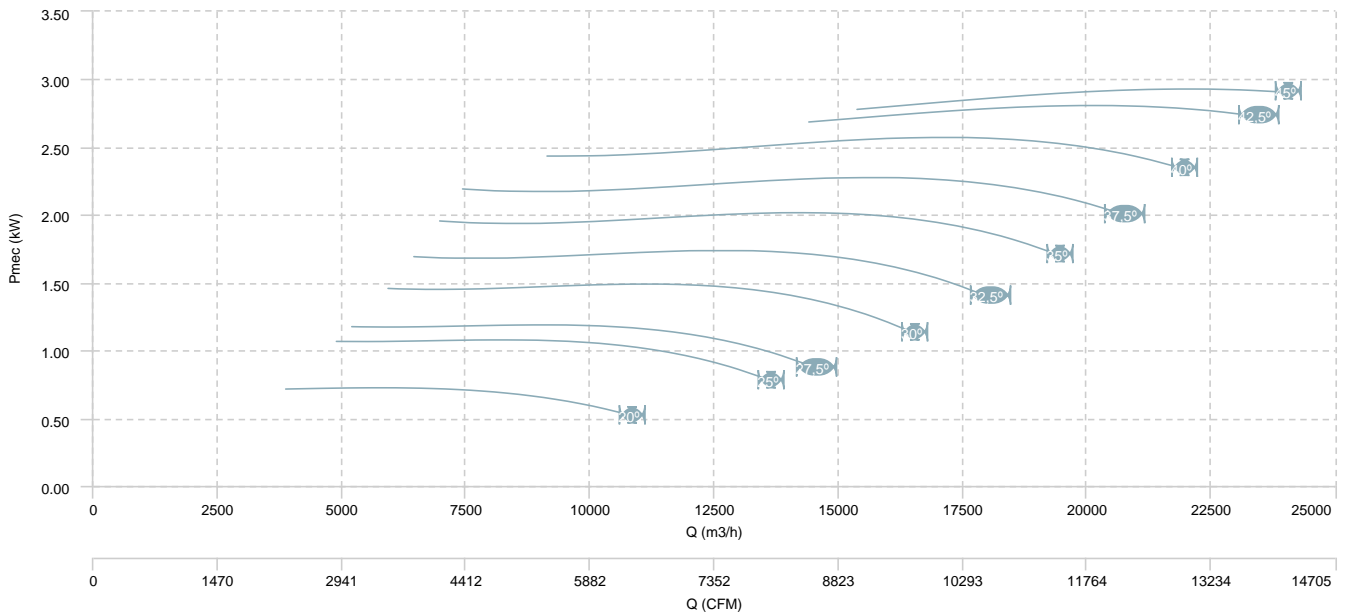

BOX HB 63 T4 (A2:9)

CAUDAL-PRESIÓN

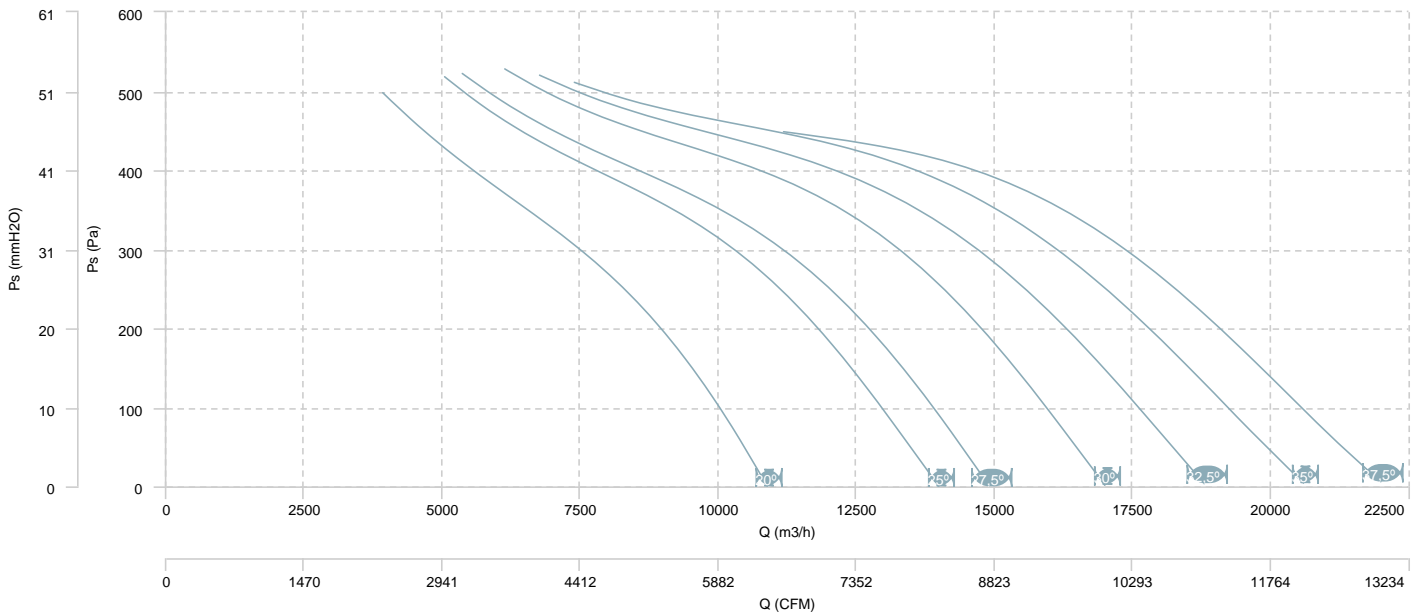

CAUDAL-POTENCIA MECÁNICA

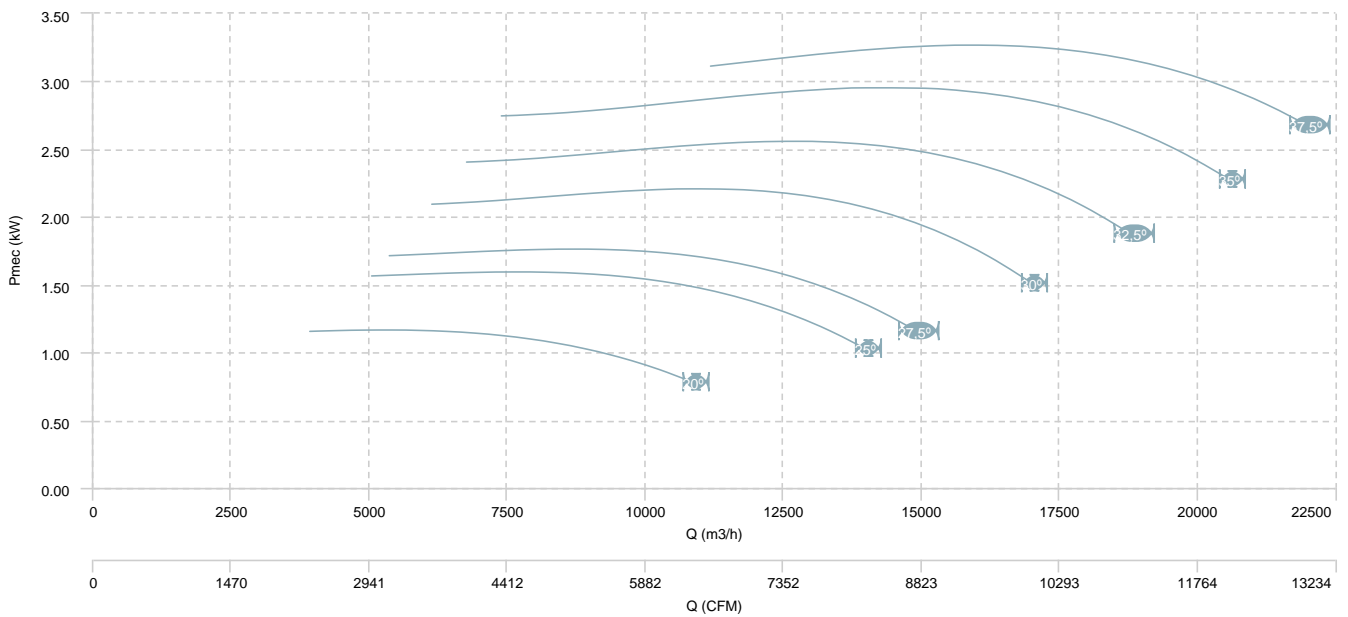

BOX HB 63 T6 (A2:6)

CAUDAL-PRESIÓN

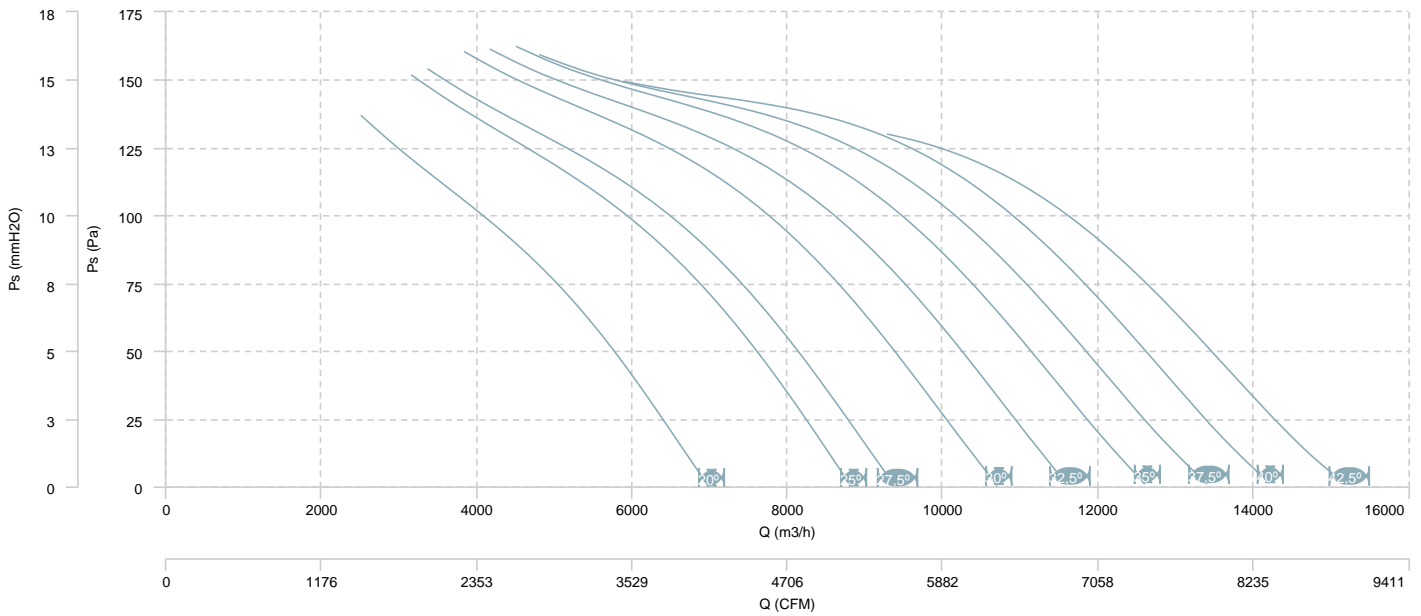

CAUDAL-POTENCIA MECÁNICA

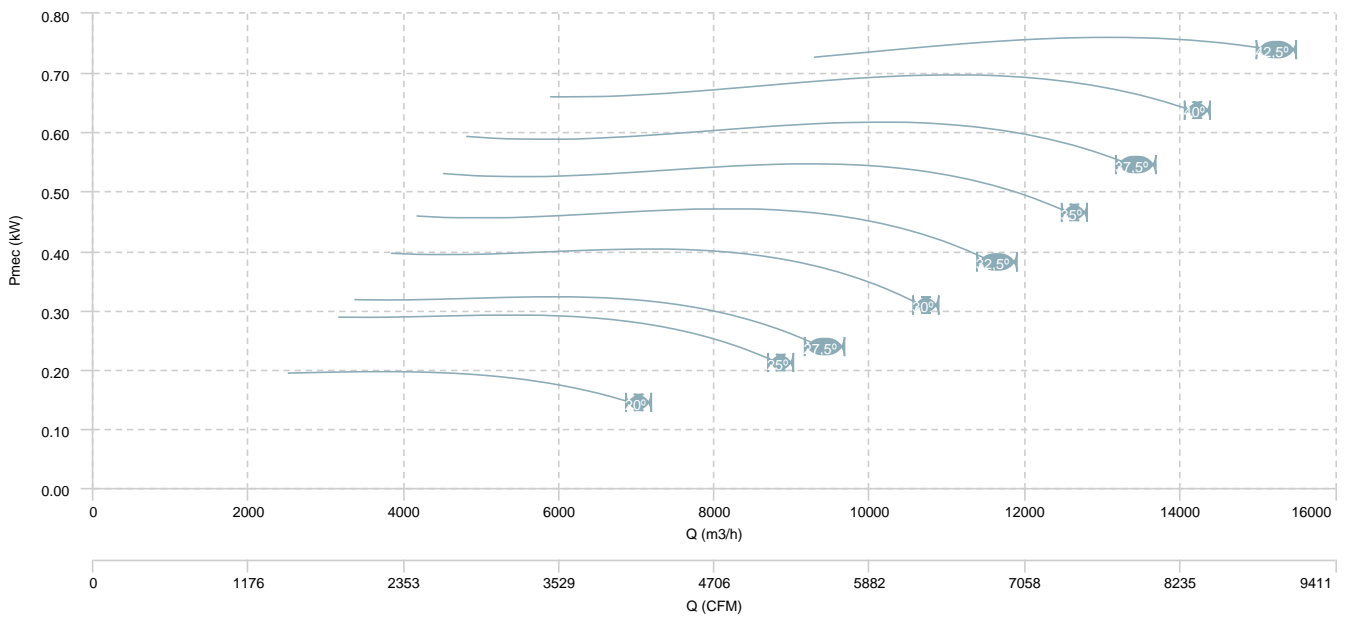

BOX HB 63 T6 (A2:9)

CAUDAL-PRESIÓN

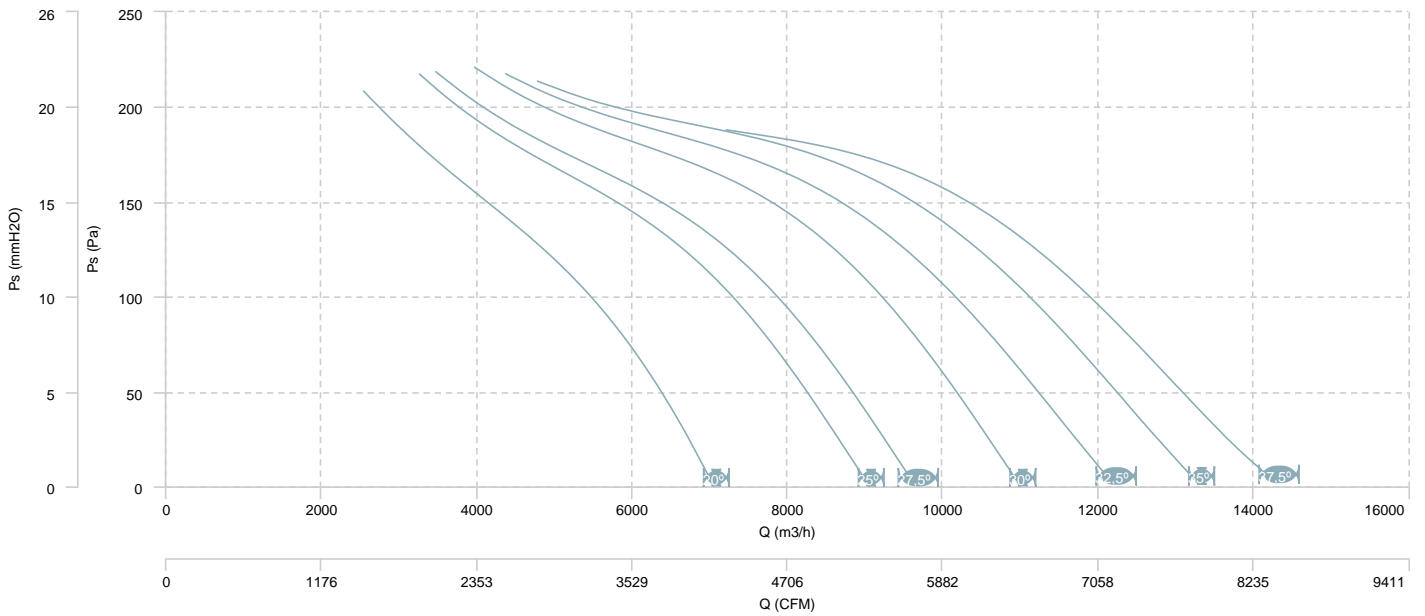

CAUDAL-POTENCIA MECÁNICA

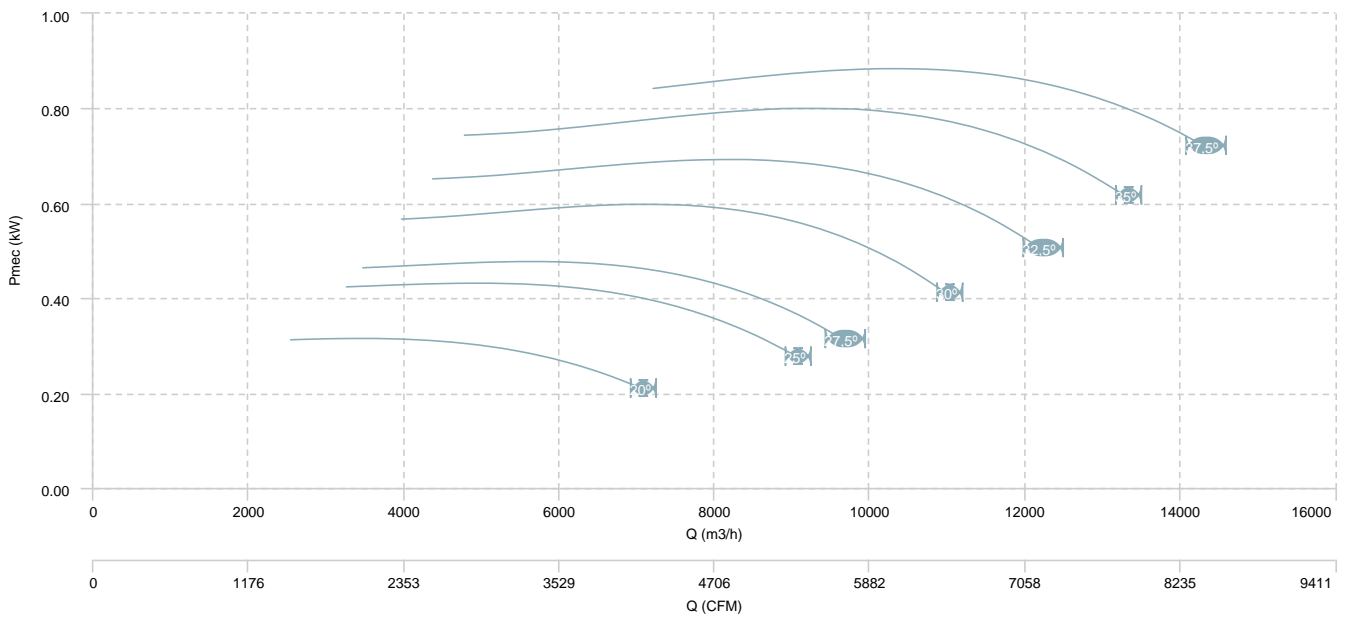

BOX HB 63 T6 (A5:6)

CAUDAL-PRESIÓN

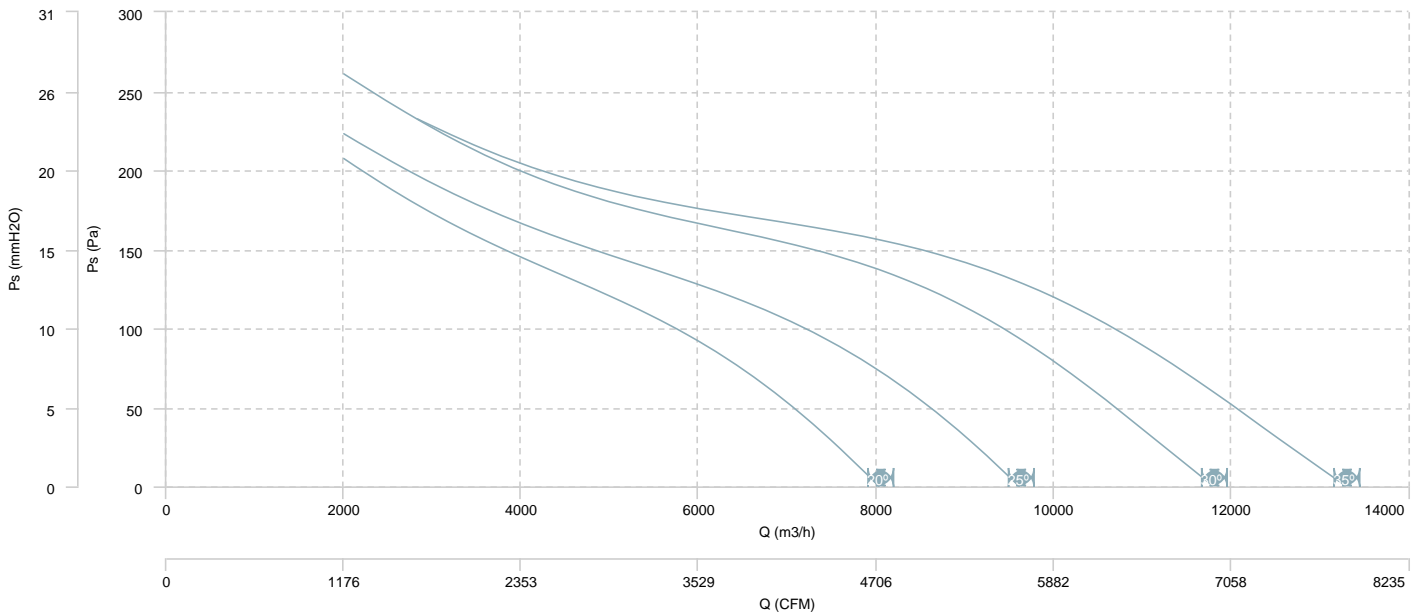

CAUDAL-POTENCIA MECÁNICA

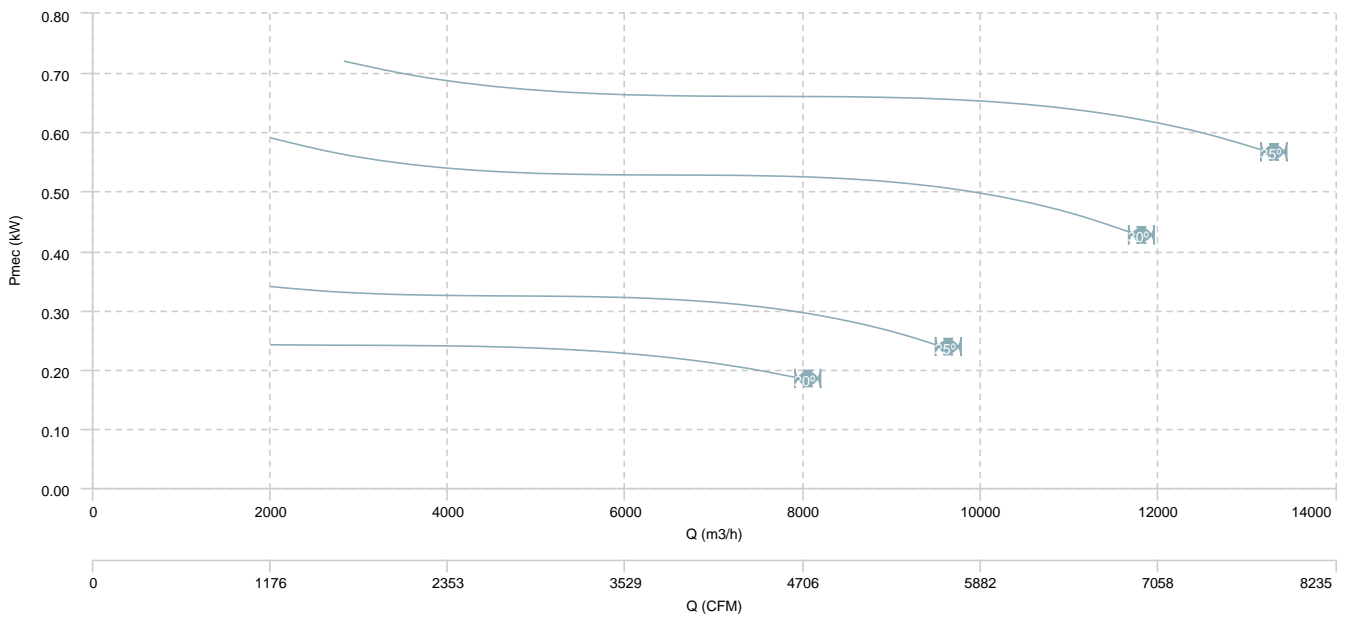

BOX HB 71 T4 (A2:6)

CAUDAL-PRESIÓN

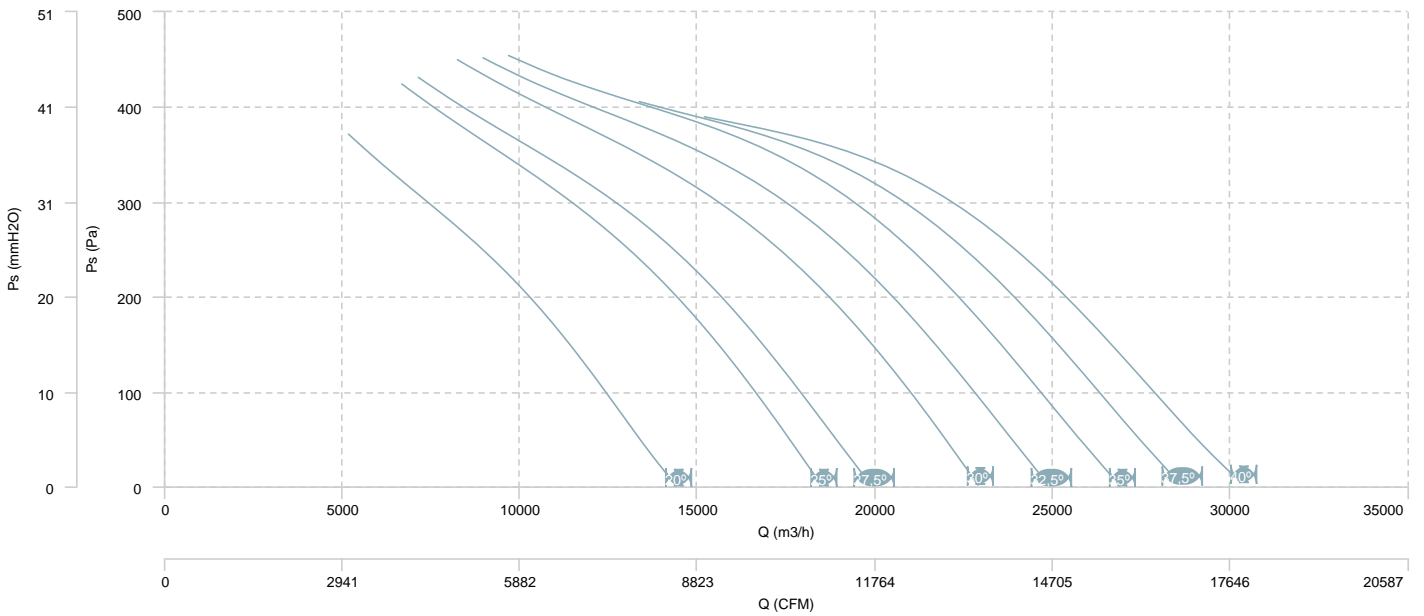

CAUDAL-POTENCIA MECÁNICA

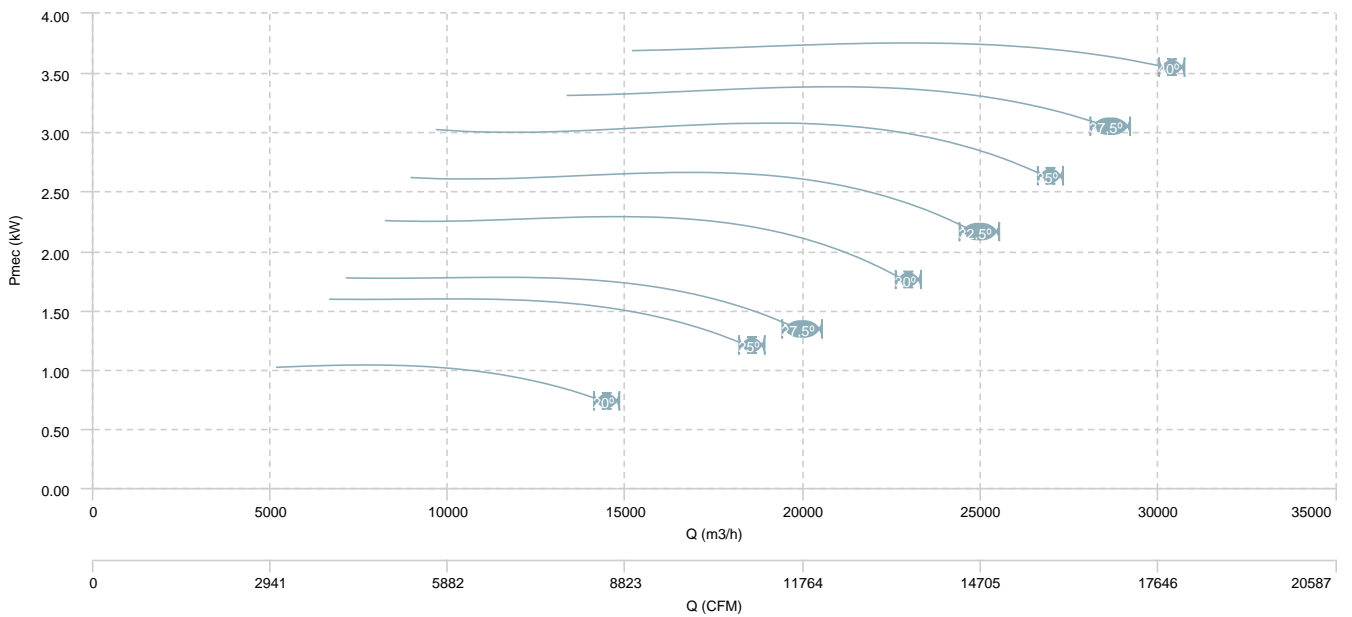

BOX HB 71 T4 (A2:9)

CAUDAL-PRESIÓN

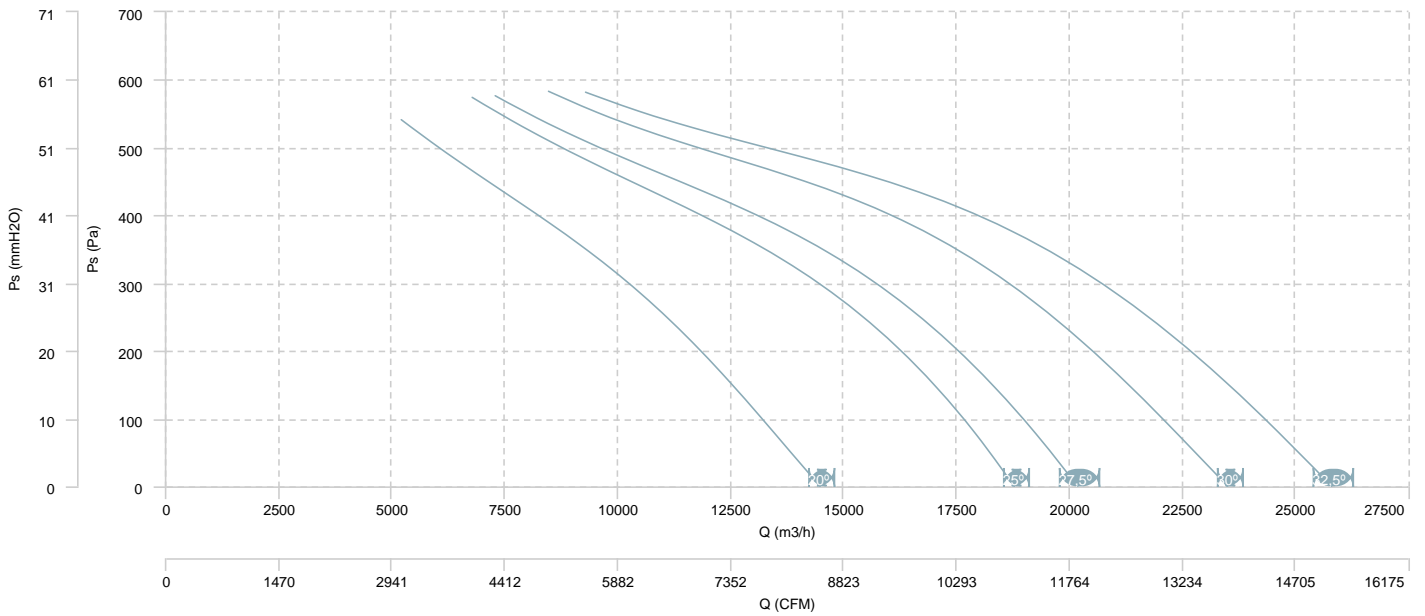

CAUDAL-POTENCIA MECÁNICA

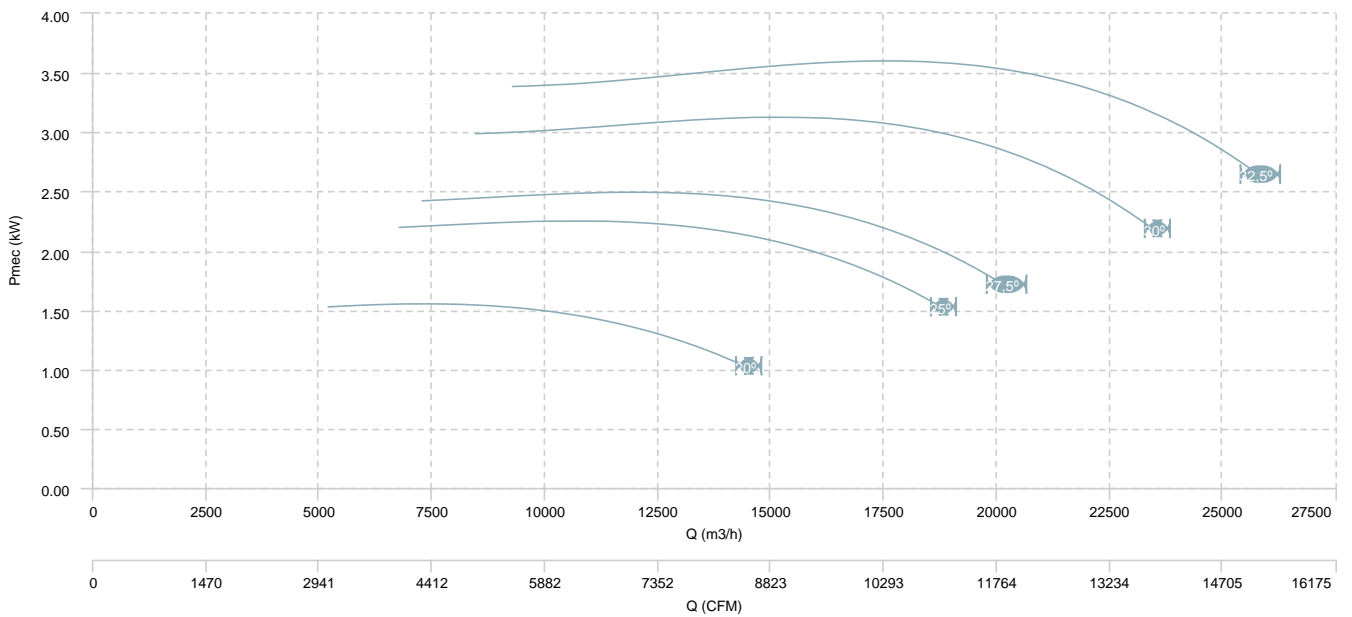

BOX HB 71 T4 (A5:6)

CAUDAL-PRESIÓN

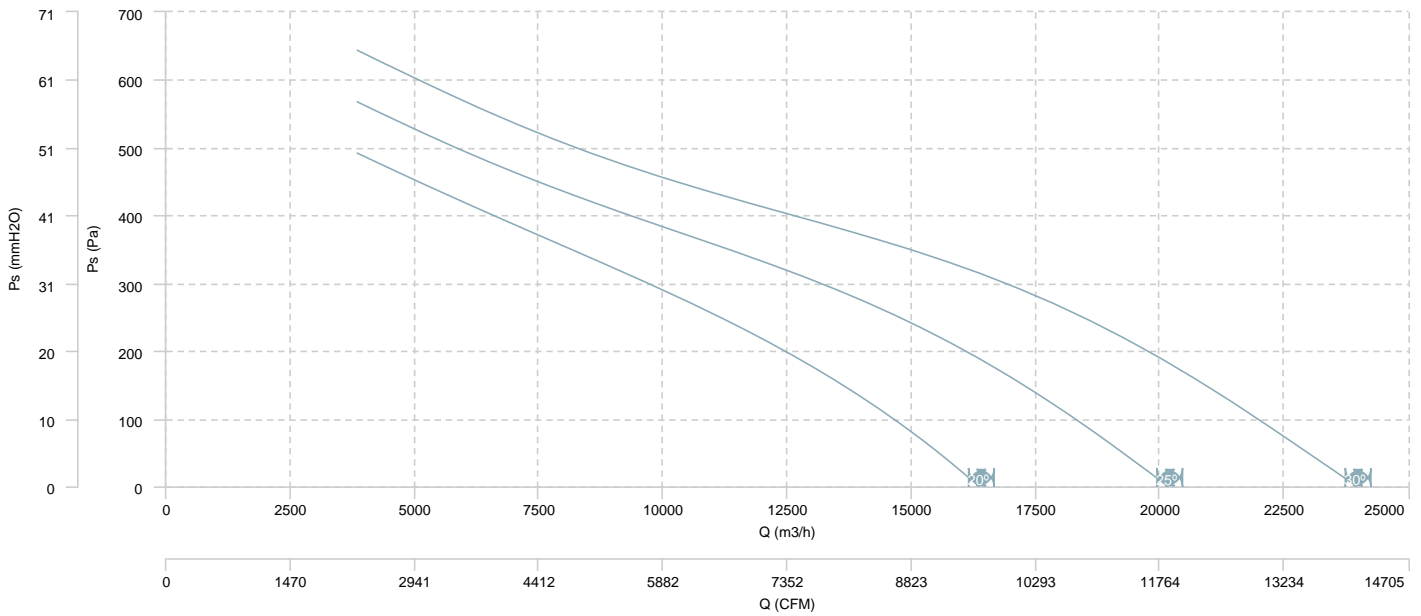

CAUDAL-POTENCIA MECÁNICA

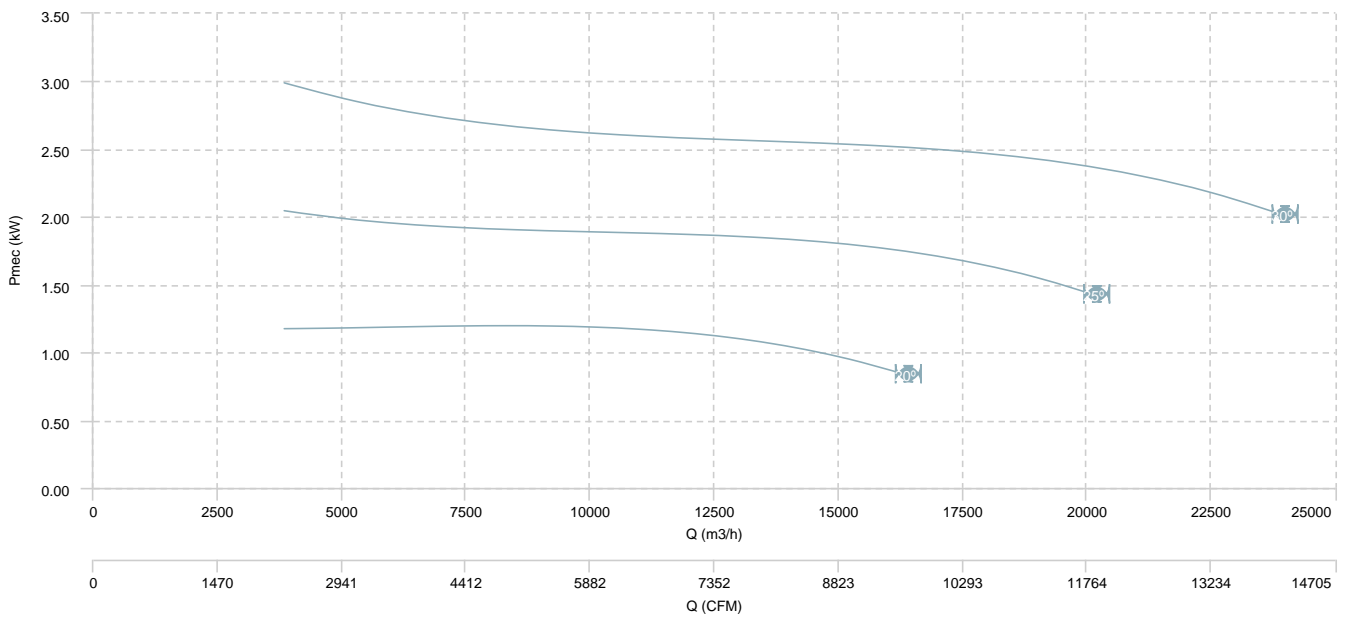

BOX HB 71 T6 (A2:6)

CAUDAL-PRESIÓN

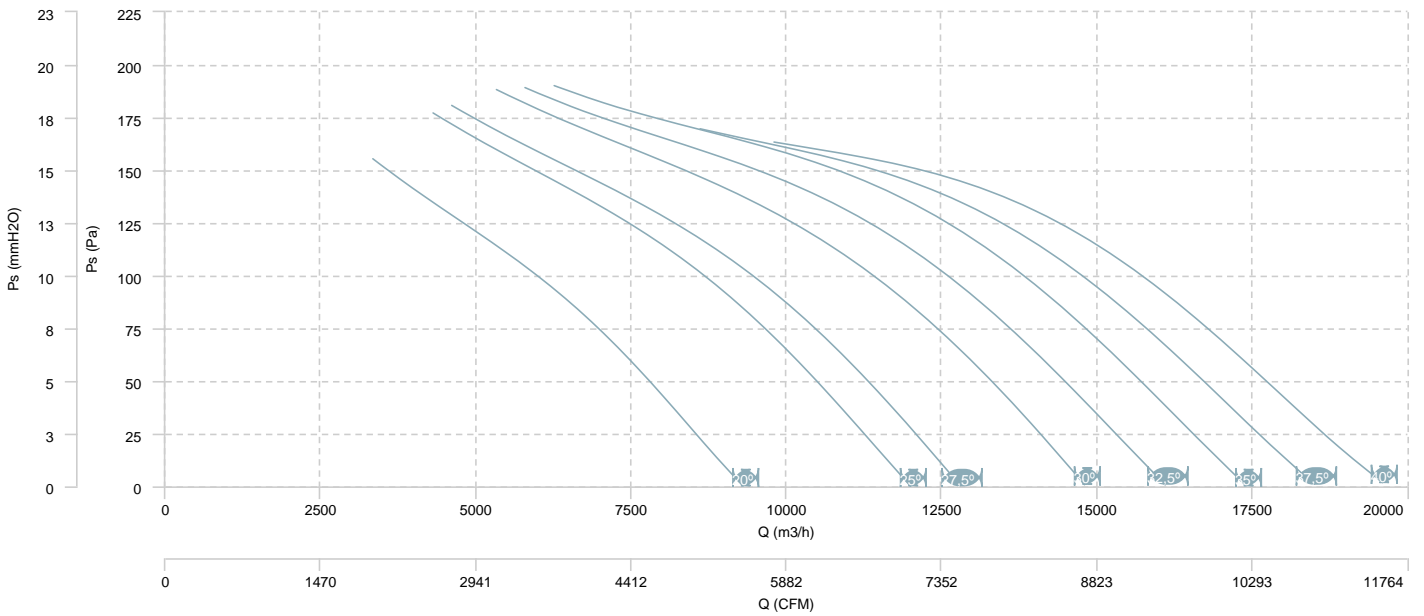

CAUDAL-POTENCIA MECÁNICA

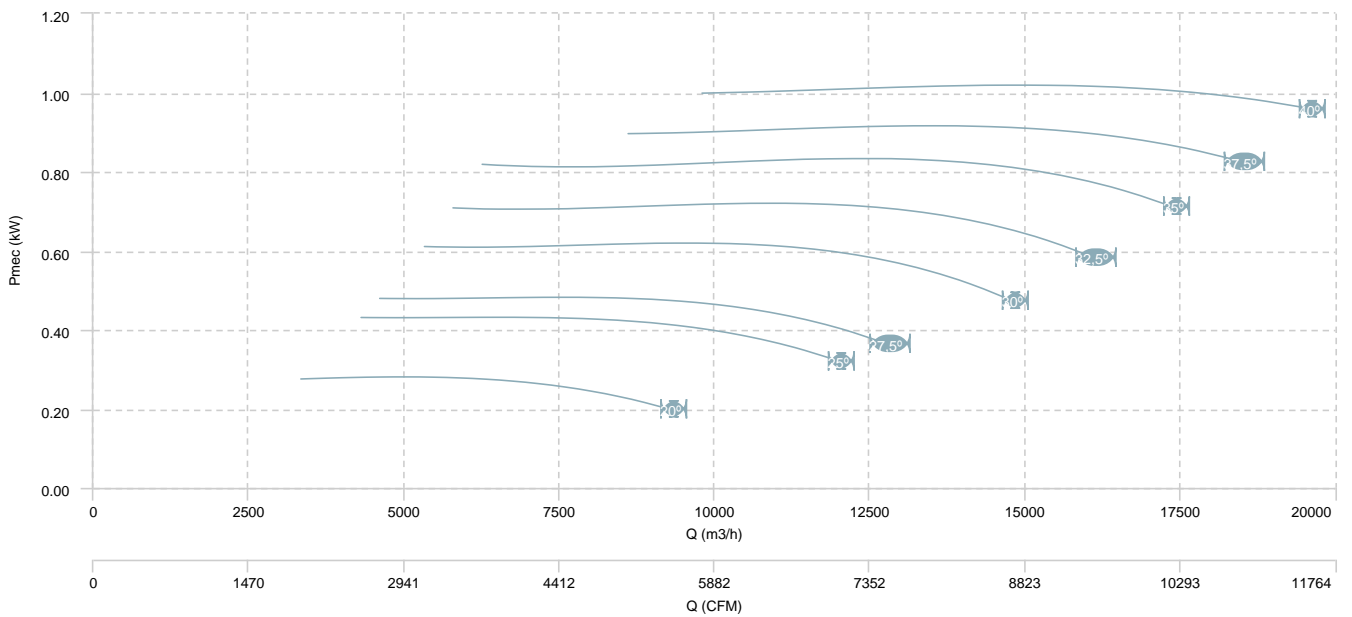

BOX HB 71 T6 (A2:9)

CAUDAL-PRESIÓN

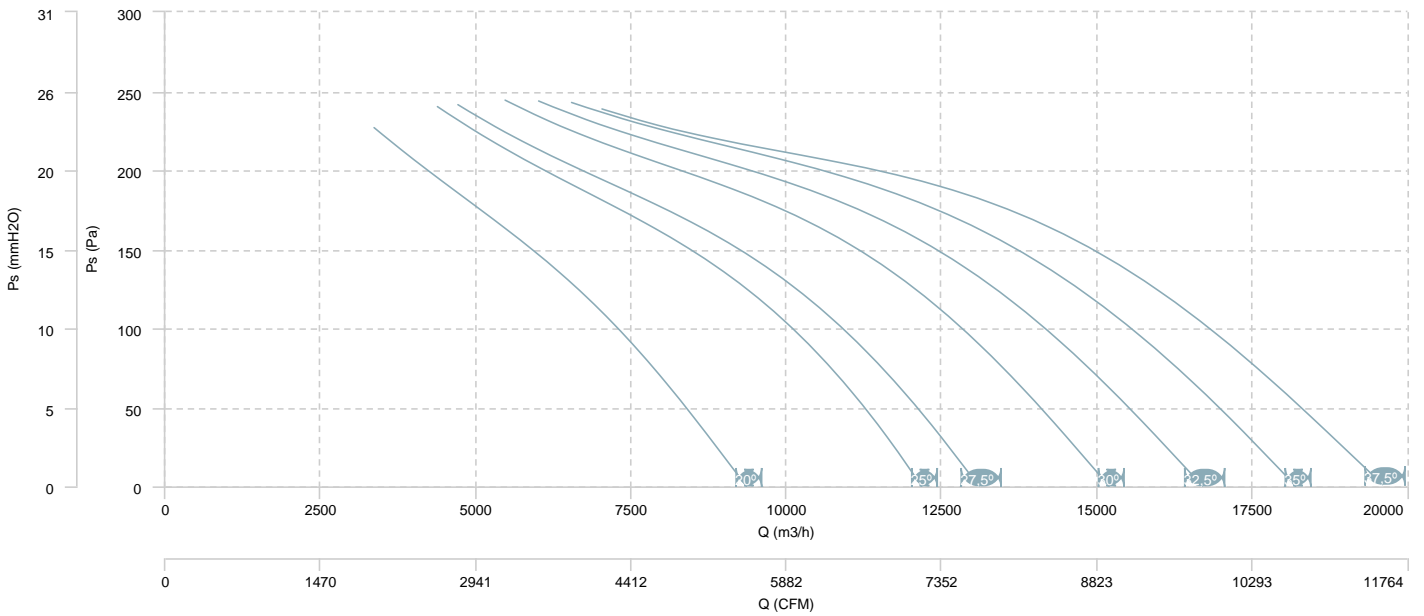

CAUDAL-POTENCIA MECÁNICA

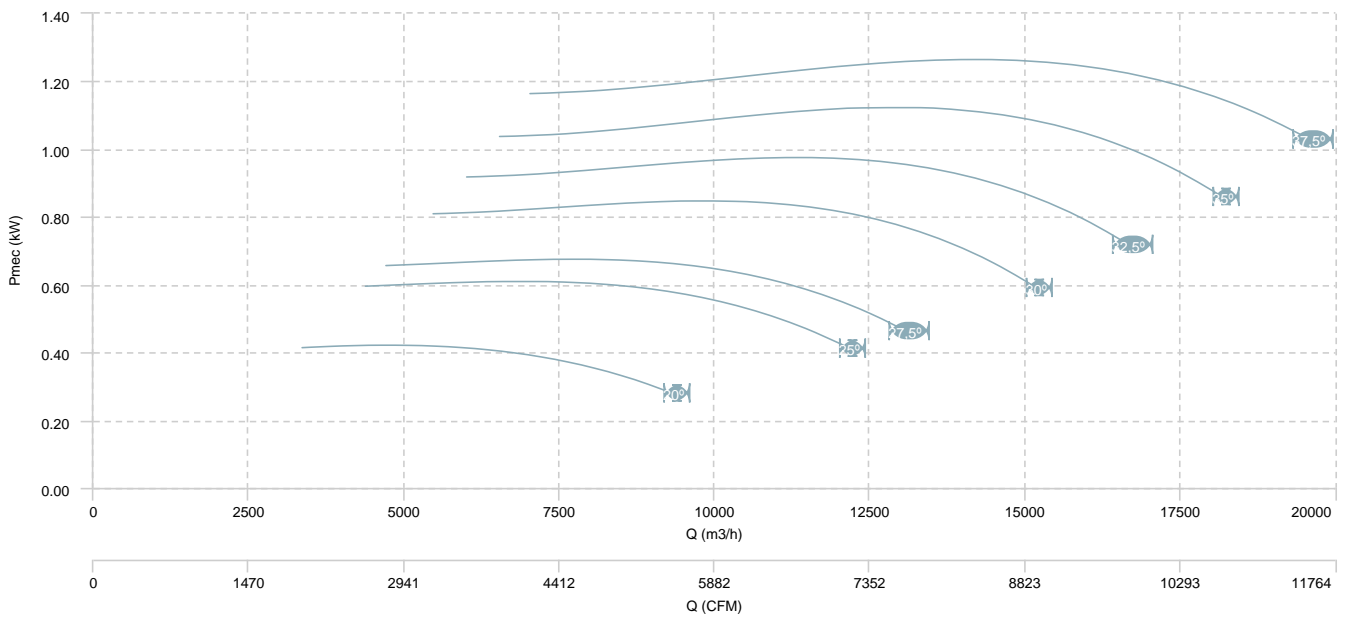

BOX HB 71 T6 (A5:6)

CAUDAL-PRESIÓN

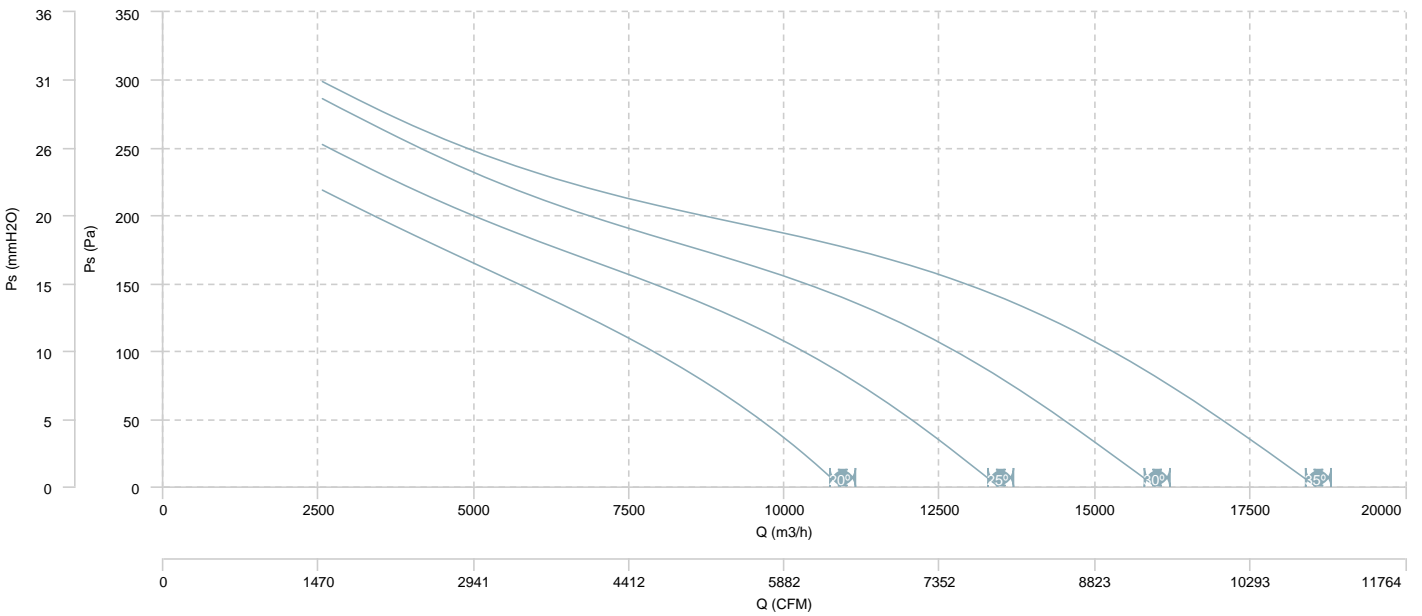

CAUDAL-POTENCIA MECÁNICA

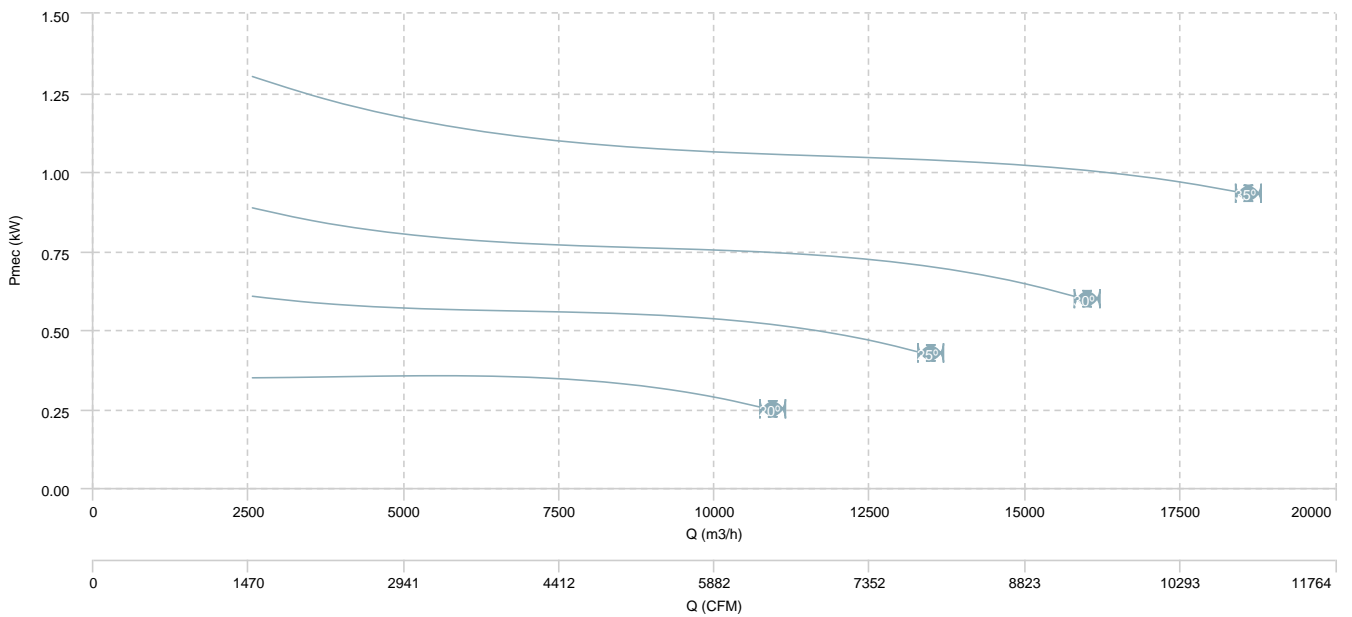

BOX HB 80 T4 (A5:6)

CAUDAL-PRESIÓN

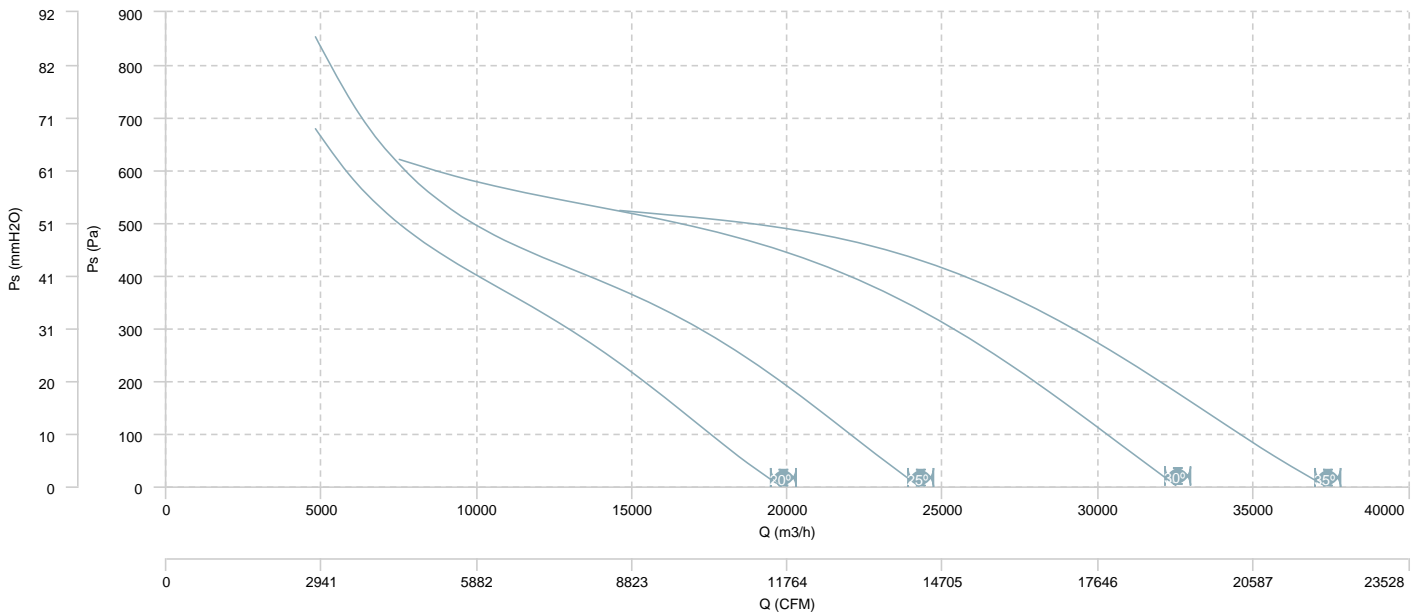

CAUDAL-POTENCIA MECÁNICA

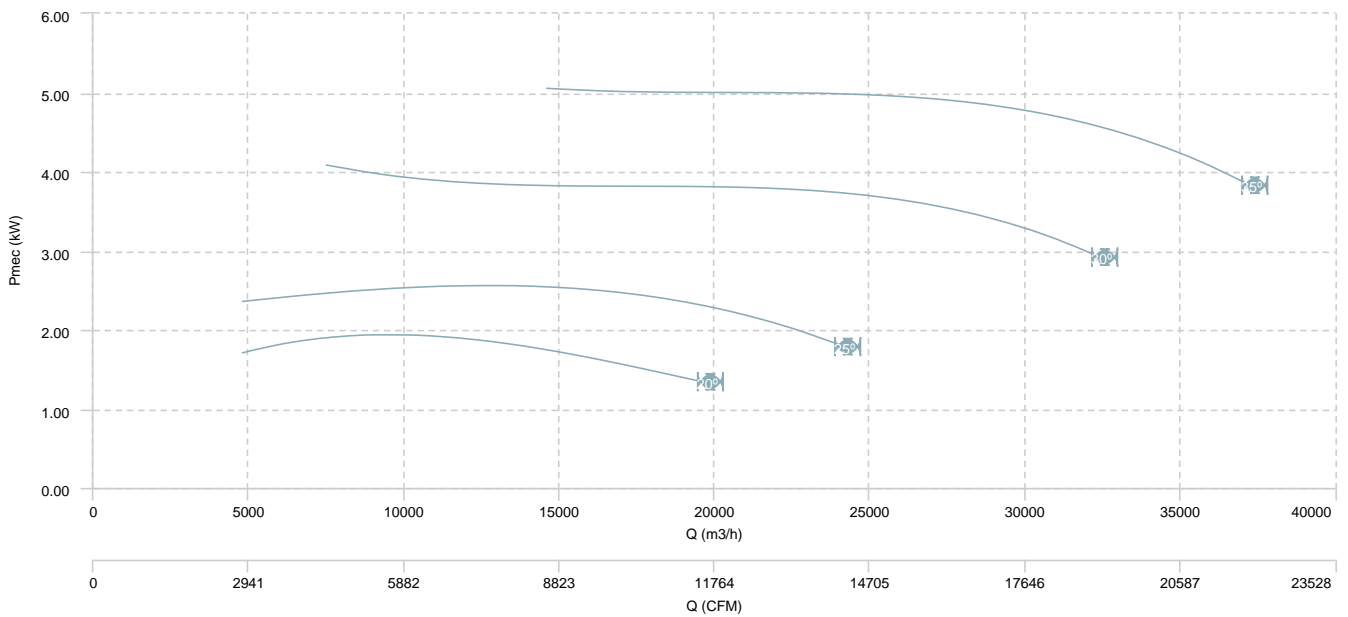

BOX HB 80 T4 (A2:6)

CAUDAL-PRESIÓN

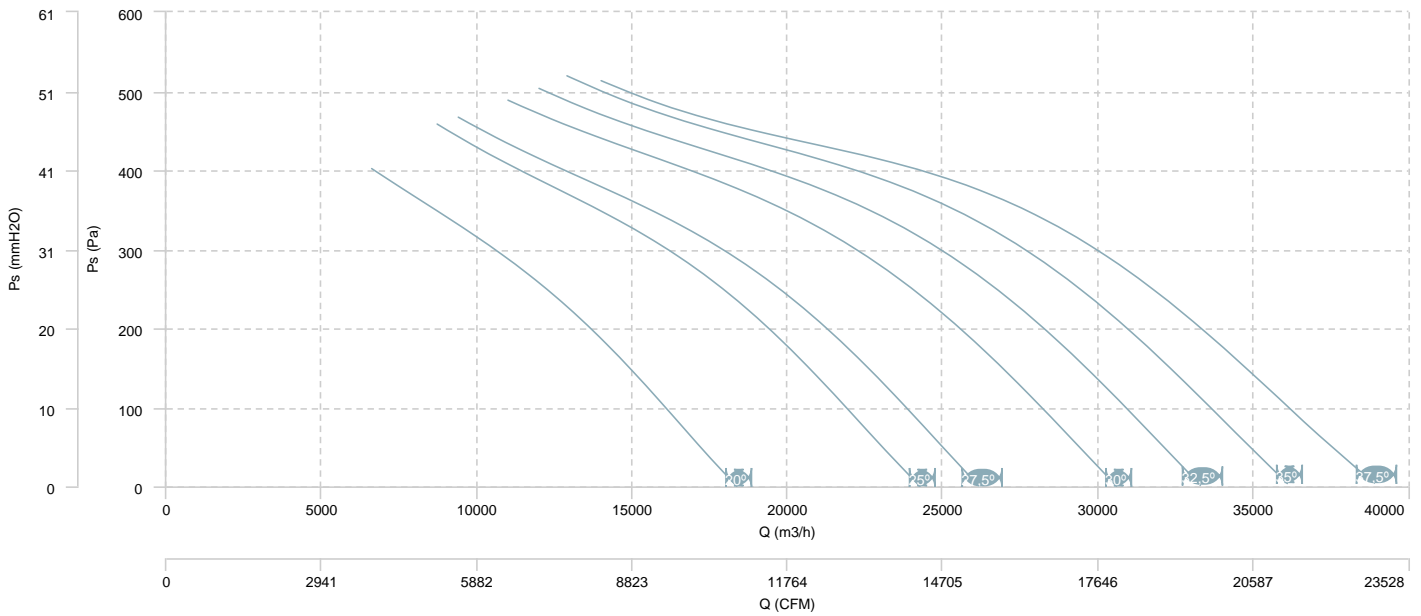

CAUDAL-POTENCIA MECÁNICA

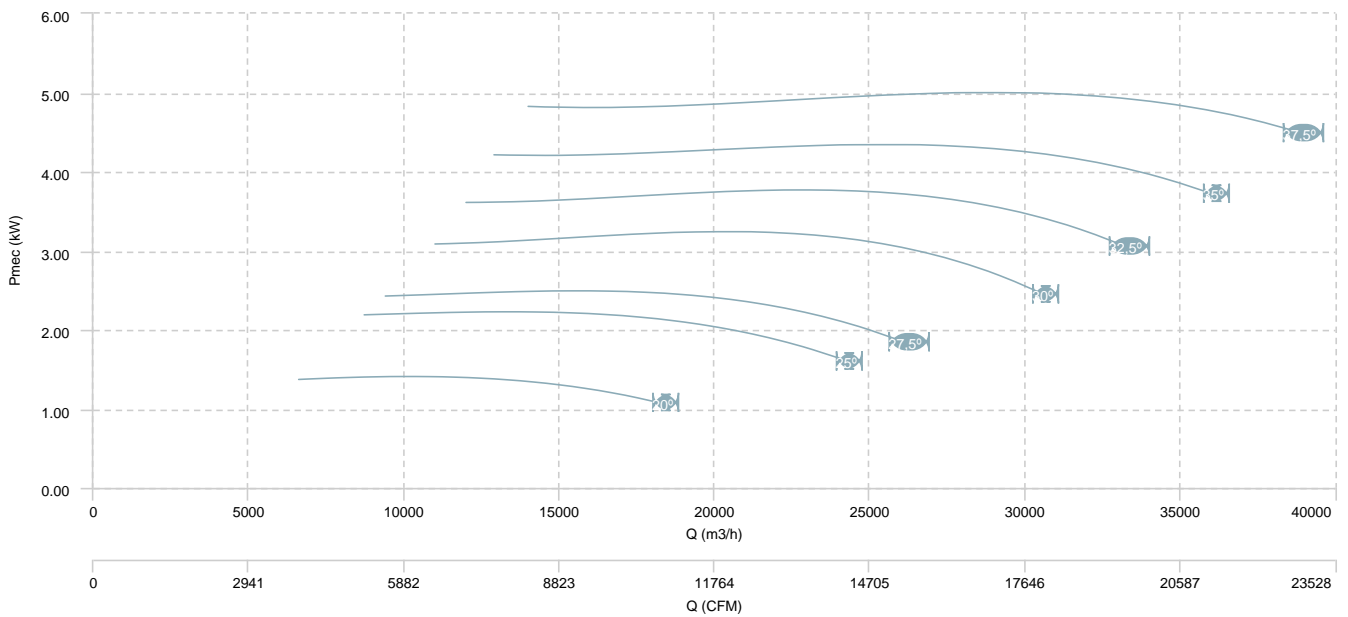

BOX HB 80 T4 (A2:9)

CAUDAL-PRESIÓN

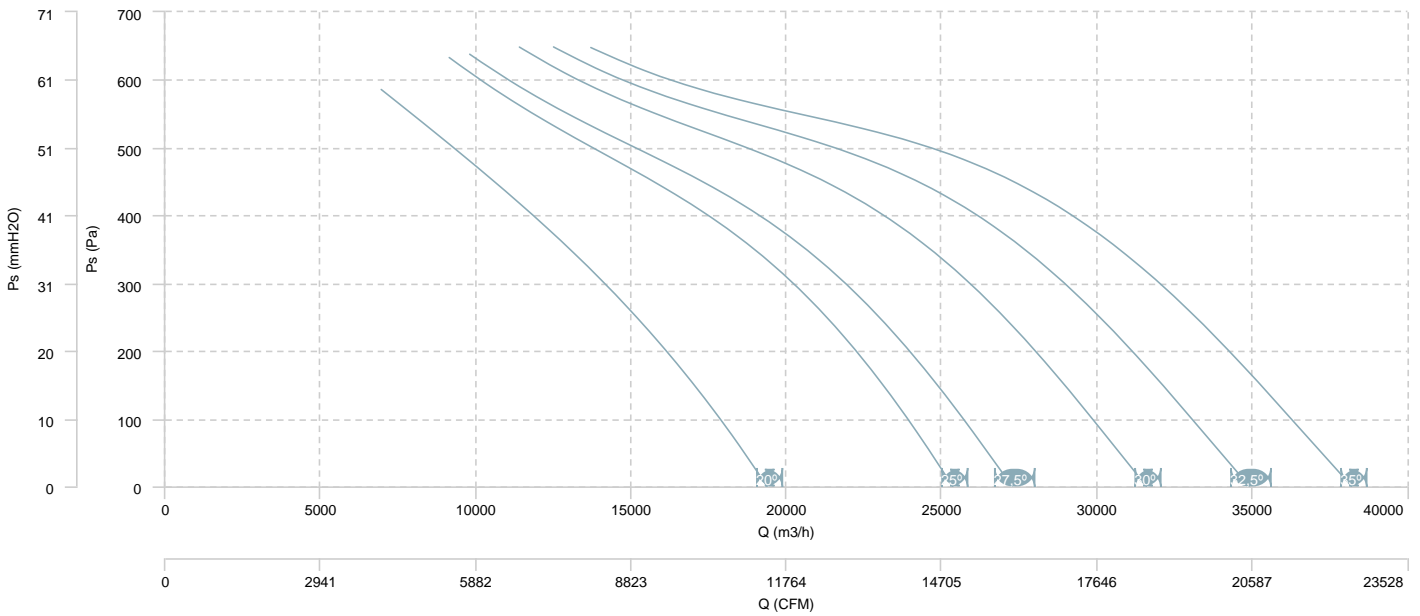

CAUDAL-POTENCIA MECÁNICA

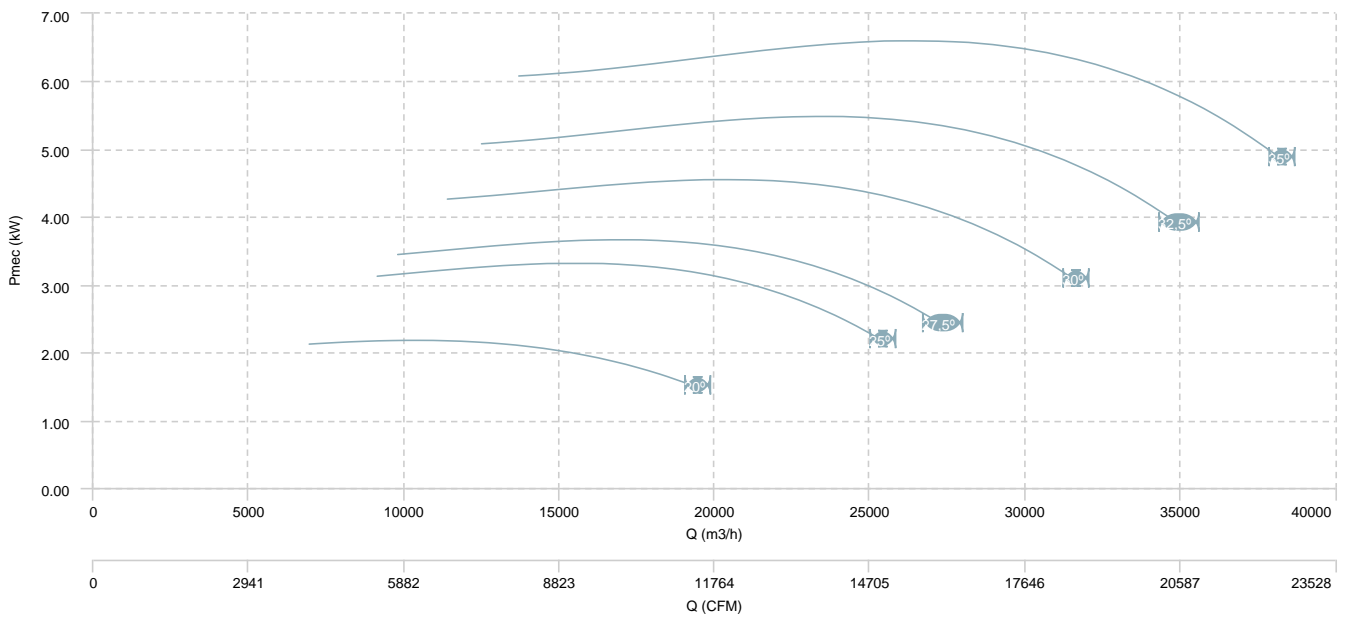

BOX HB 80 T6 (A2:6)

CAUDAL-PRESIÓN

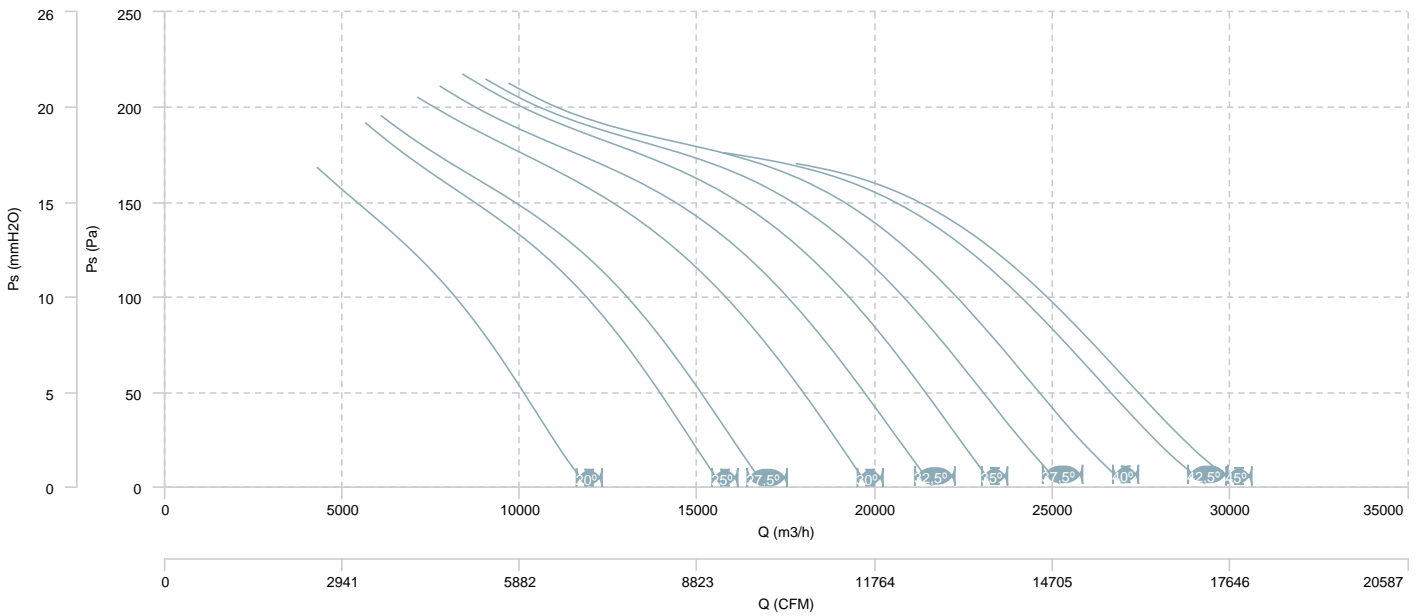

CAUDAL-POTENCIA MECÁNICA

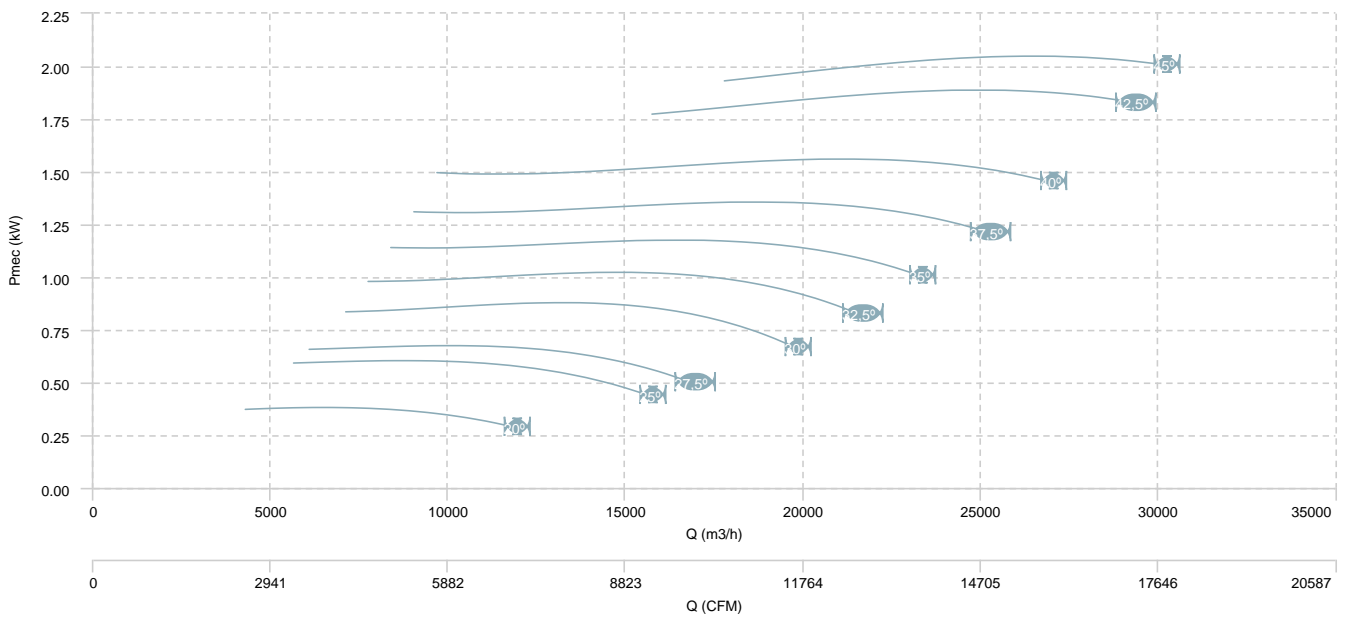

BOX HB 80 T6 (A2:9)

CAUDAL-PRESIÓN

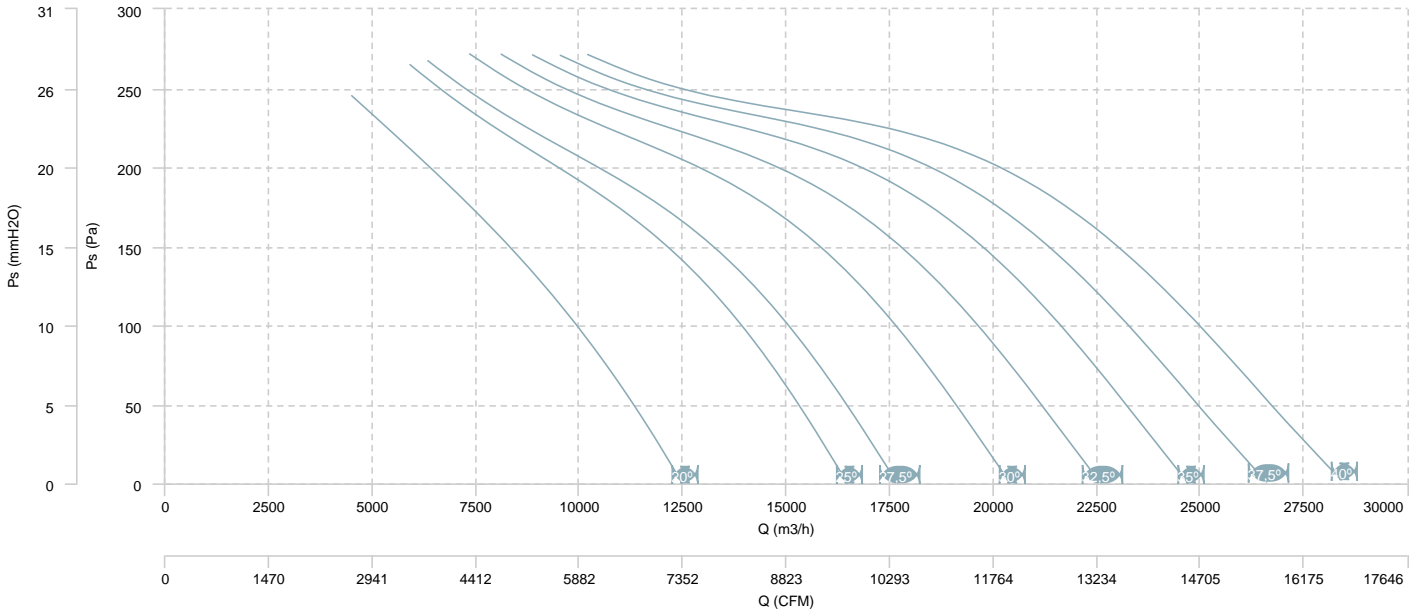

CAUDAL-POTENCIA MECÁNICA

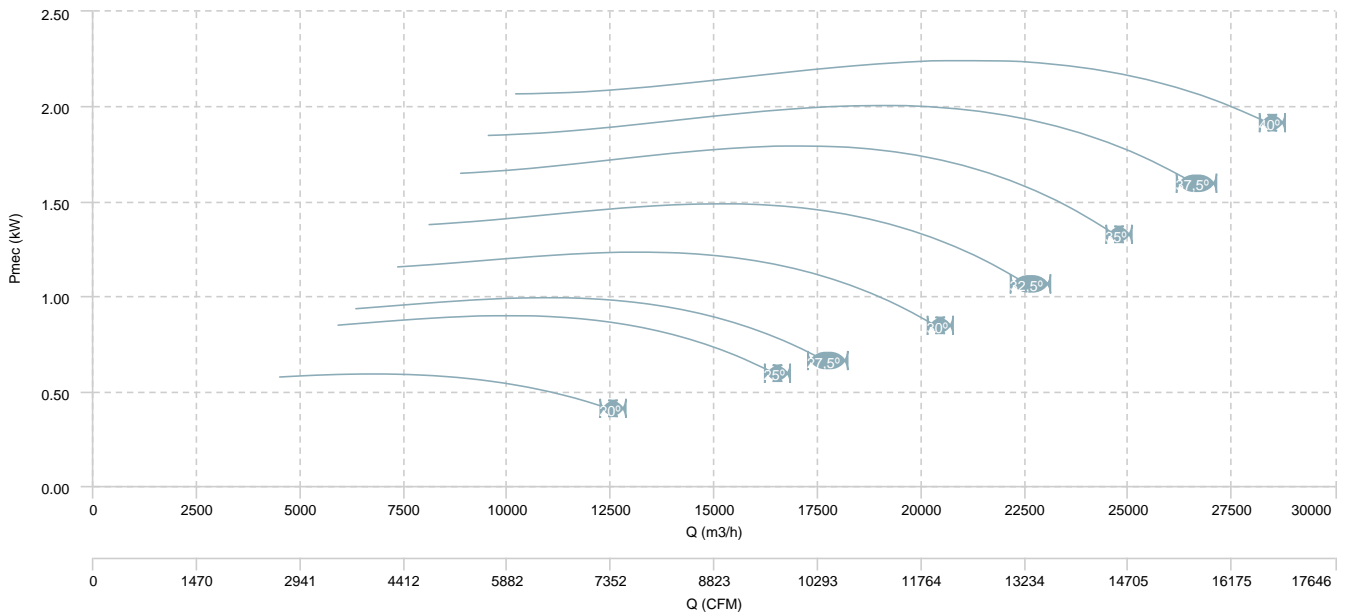

BOX HB 80 T6 (A5:6)

CAUDAL-PRESIÓN

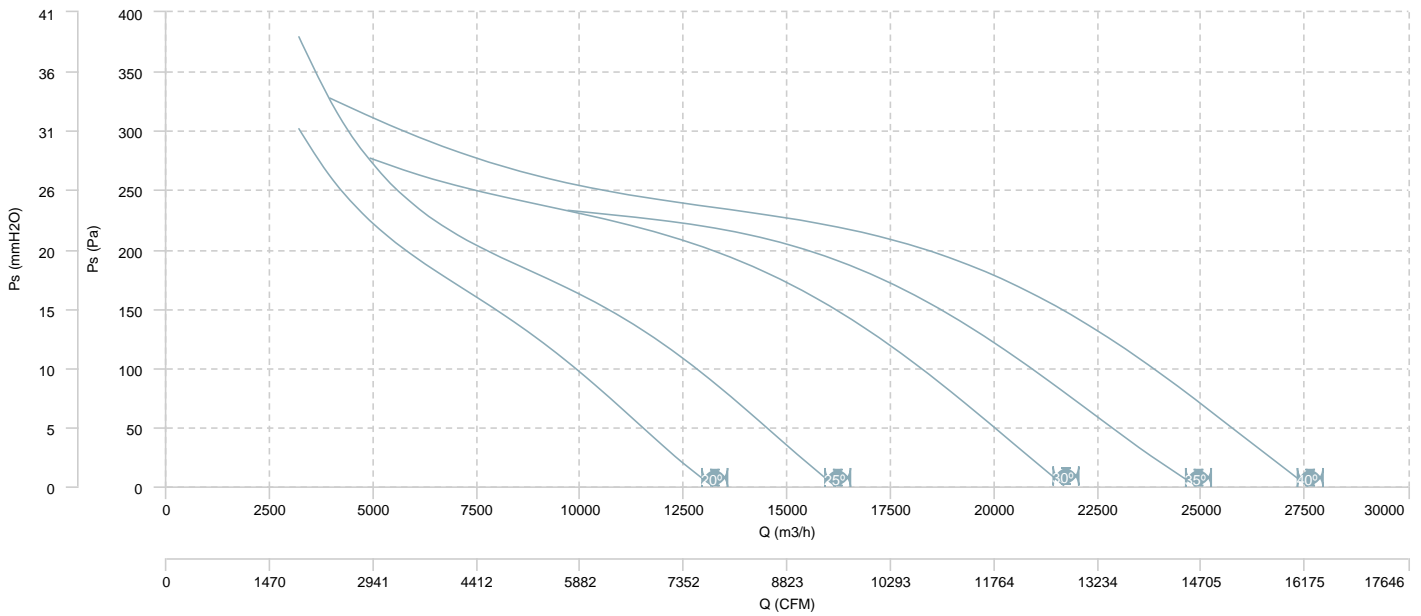

CAUDAL-POTENCIA MECÁNICA

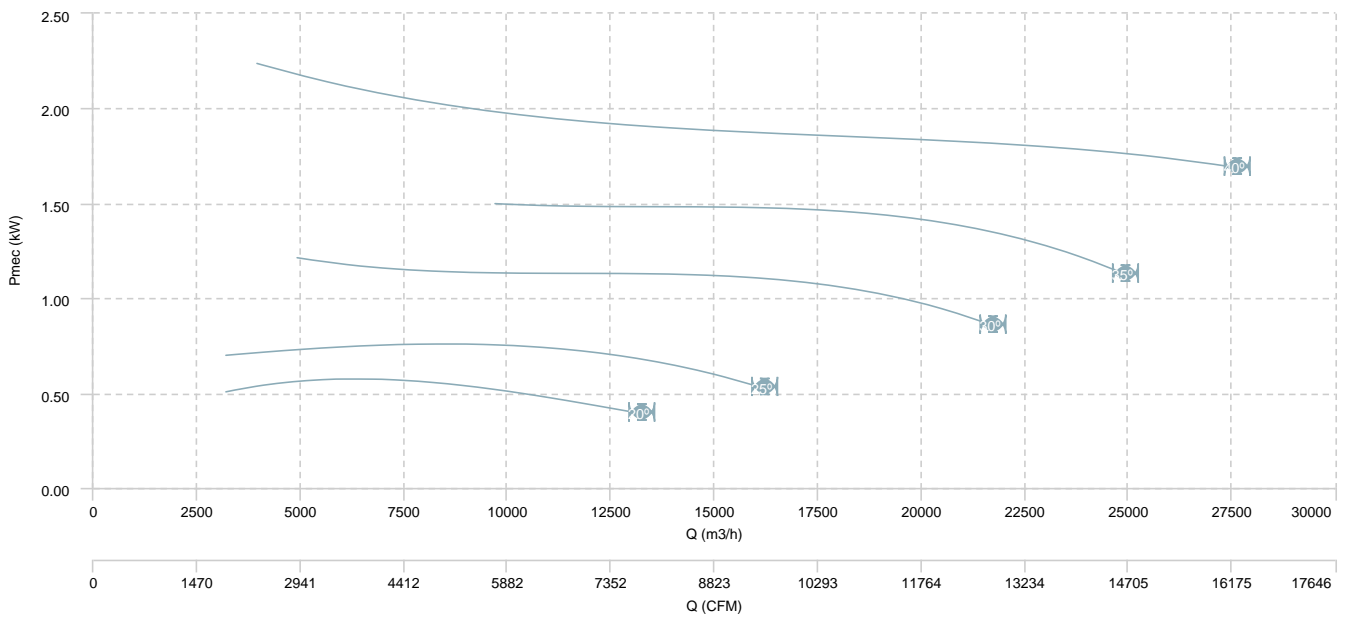

BOX HB 90 T4 (A6:3)

CAUDAL-PRESIÓN

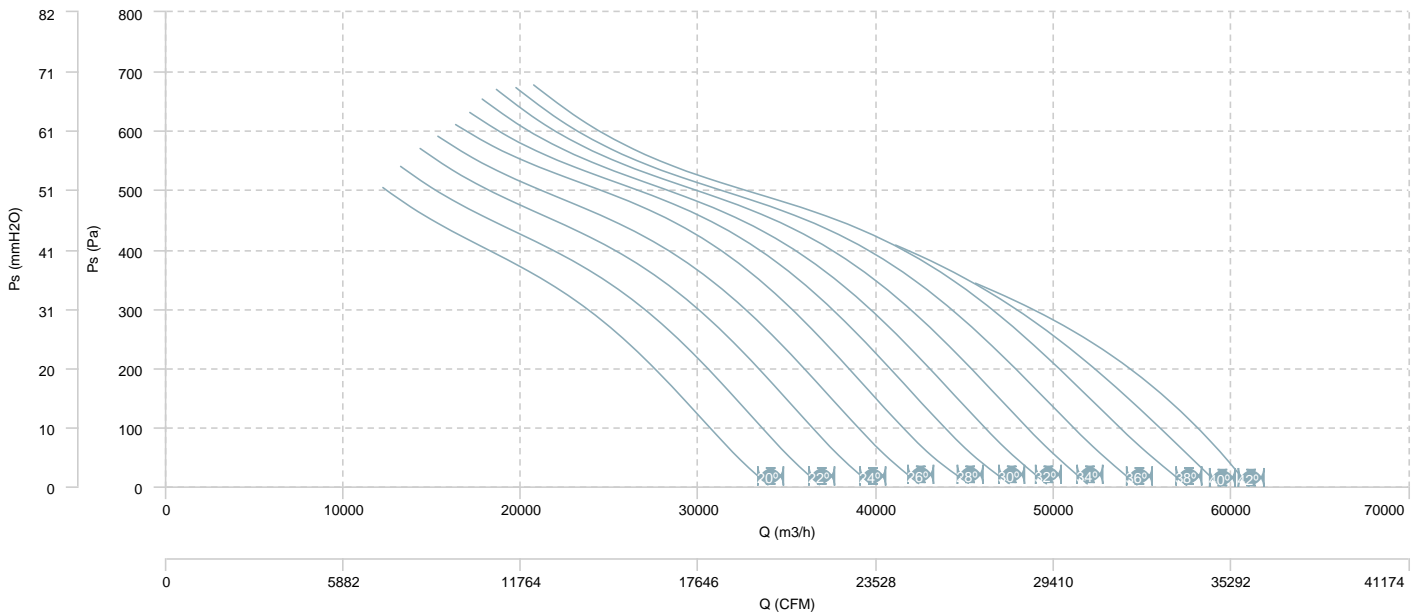

CAUDAL-POTENCIA MECÁNICA

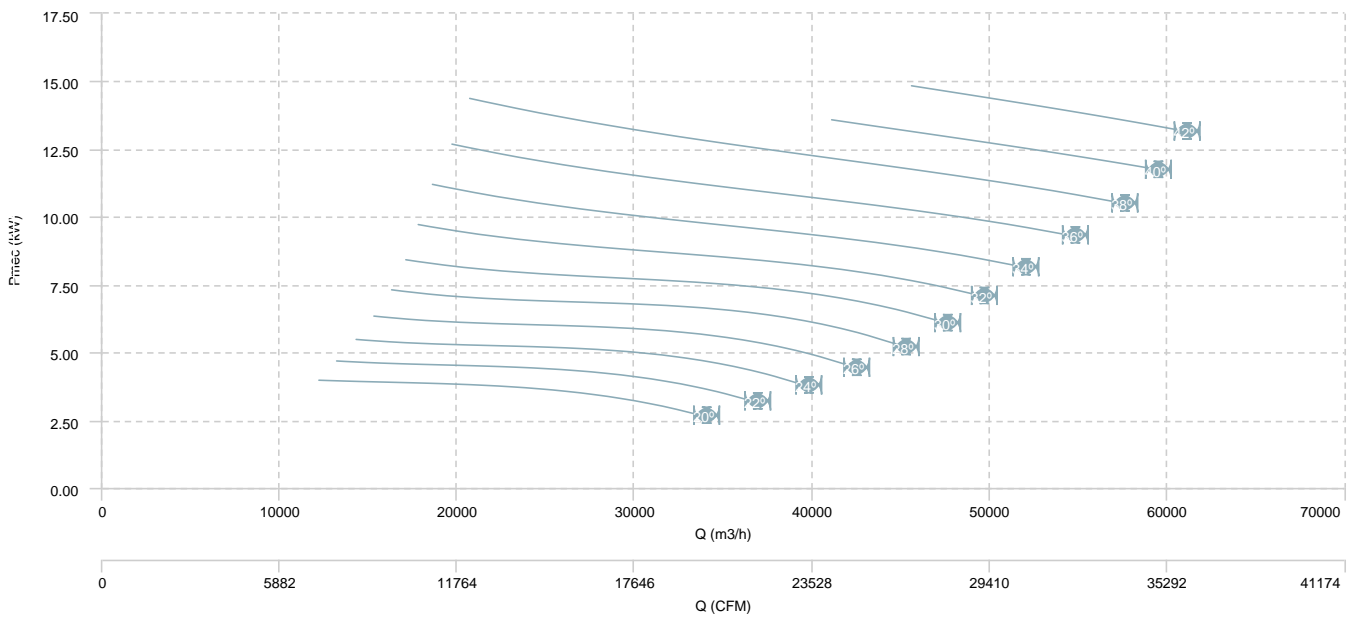

BOX HB 90 T4 (A6:6)

CAUDAL-PRESIÓN

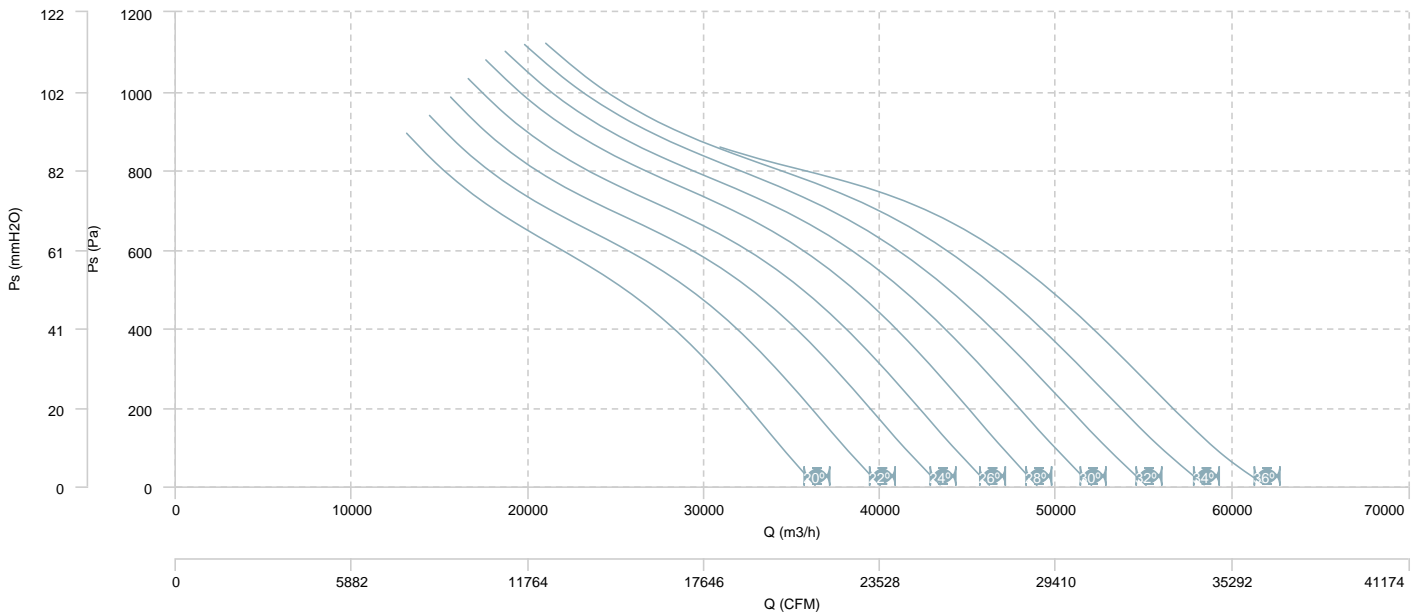

CAUDAL-POTENCIA MECÁNICA

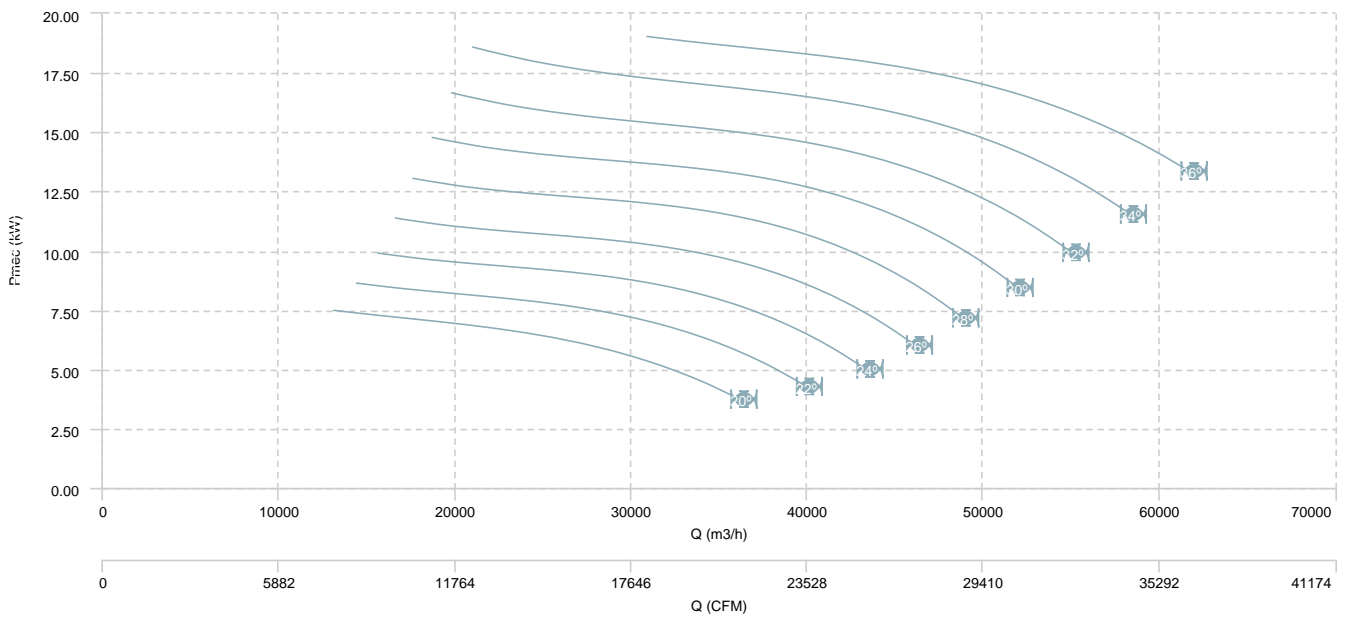

BOX HB 90 T6 (A6:3)

CAUDAL-PRESIÓN

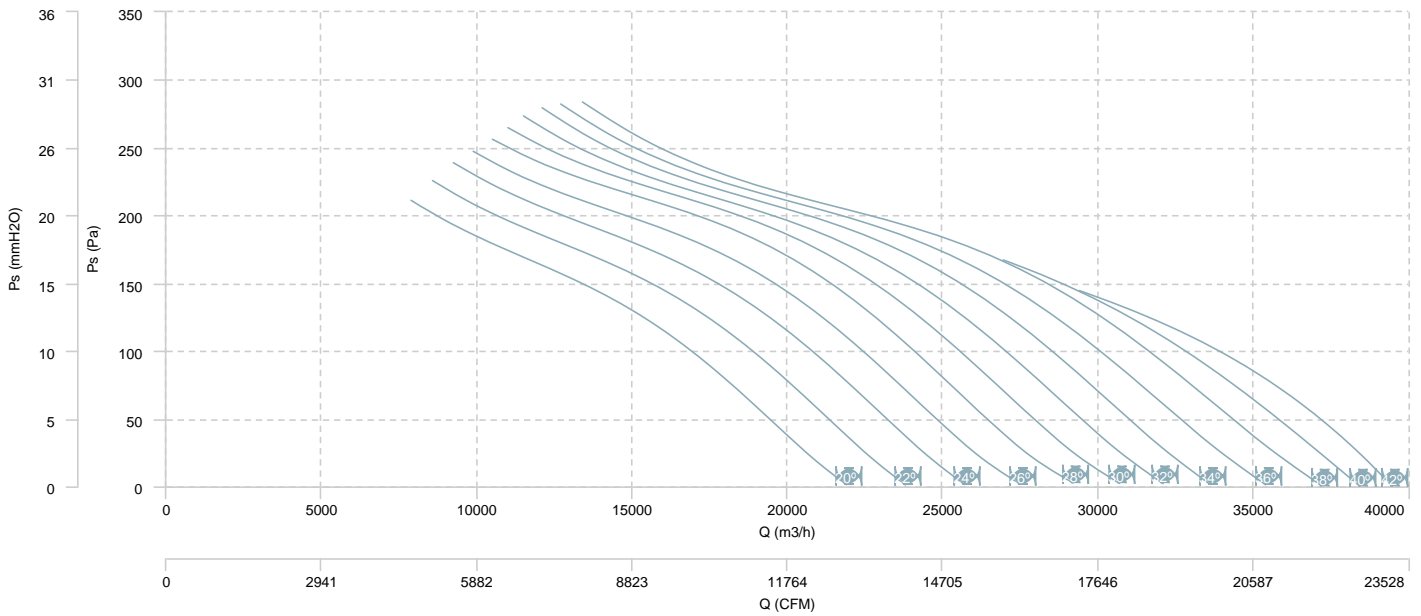

CAUDAL-POTENCIA MECÁNICA

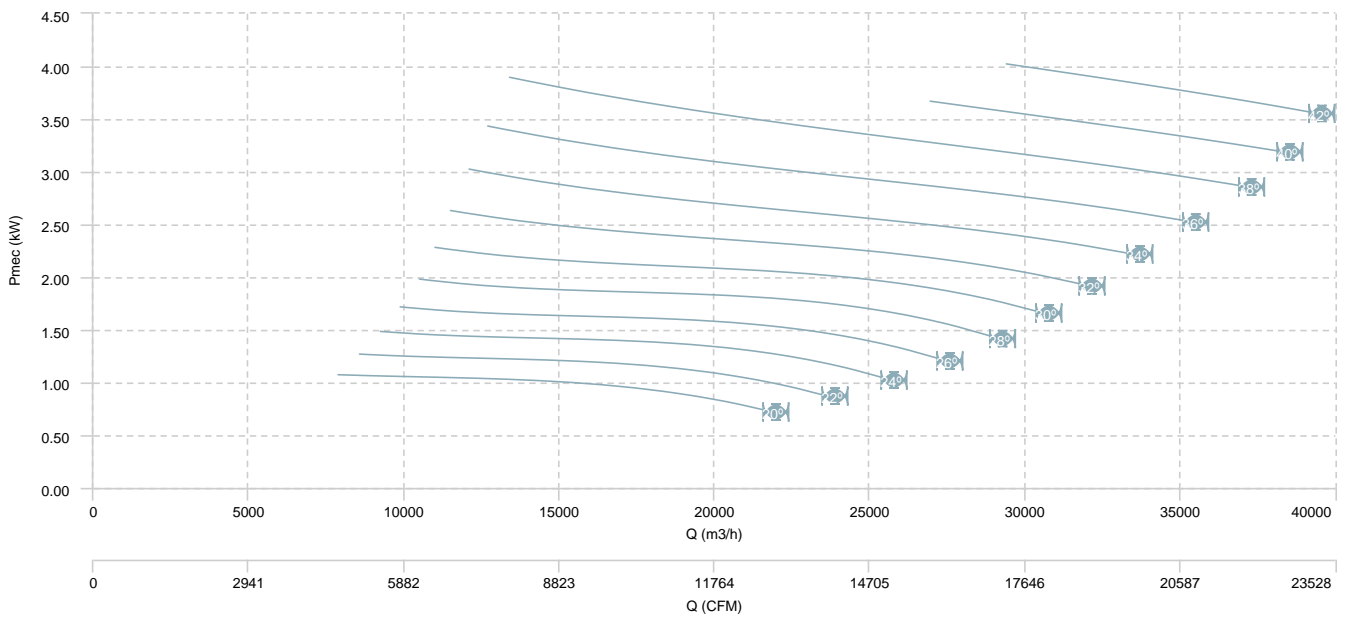

BOX HB 90 T6 (A6:6)

CAUDAL-PRESIÓN

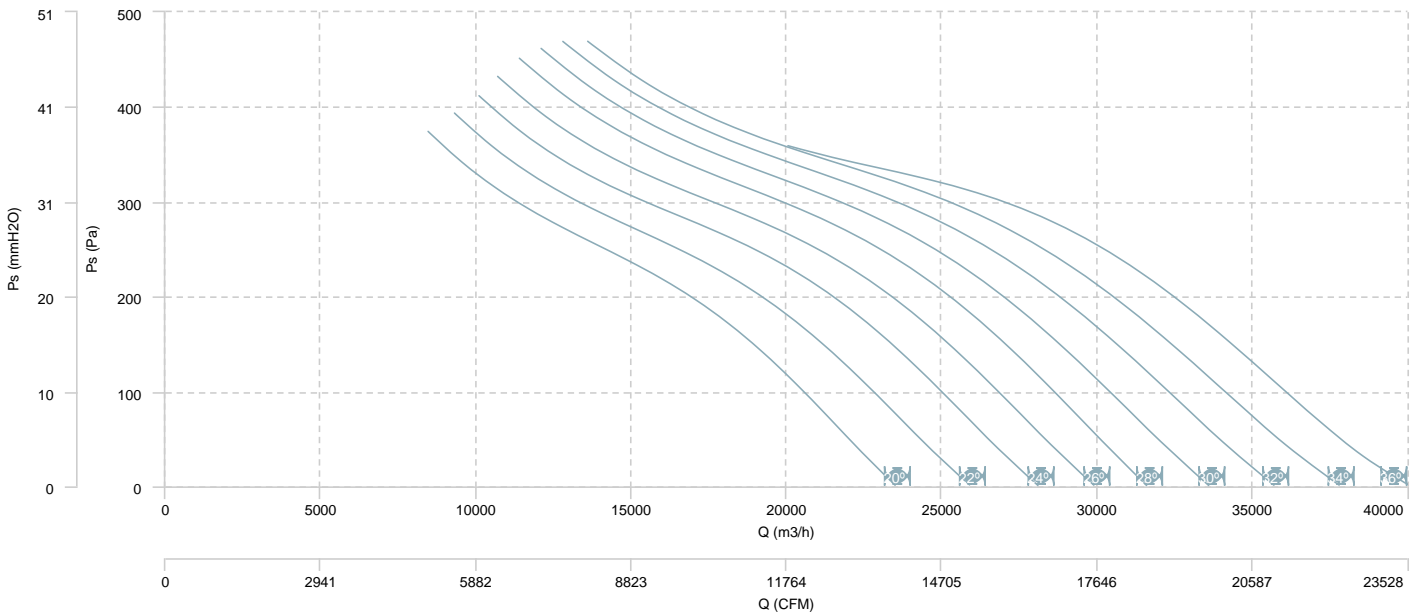

CAUDAL-POTENCIA MECÁNICA

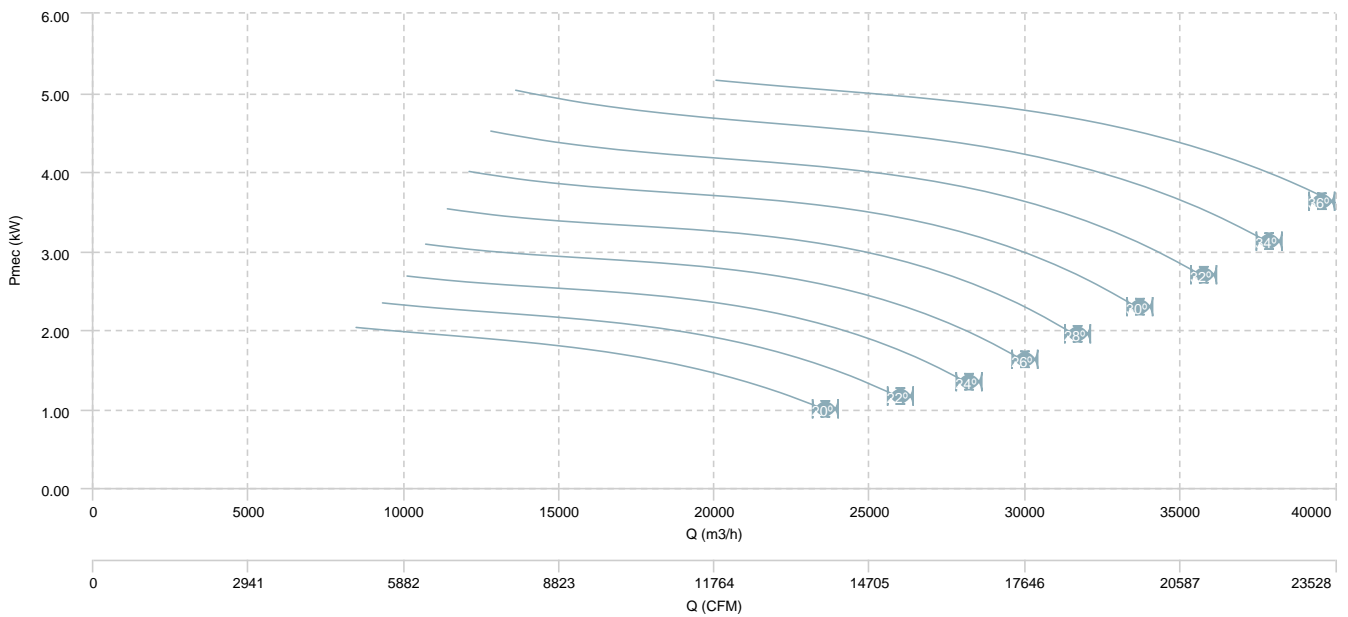

BOX HB 100 T4 (A6:3)

CAUDAL-PRESIÓN

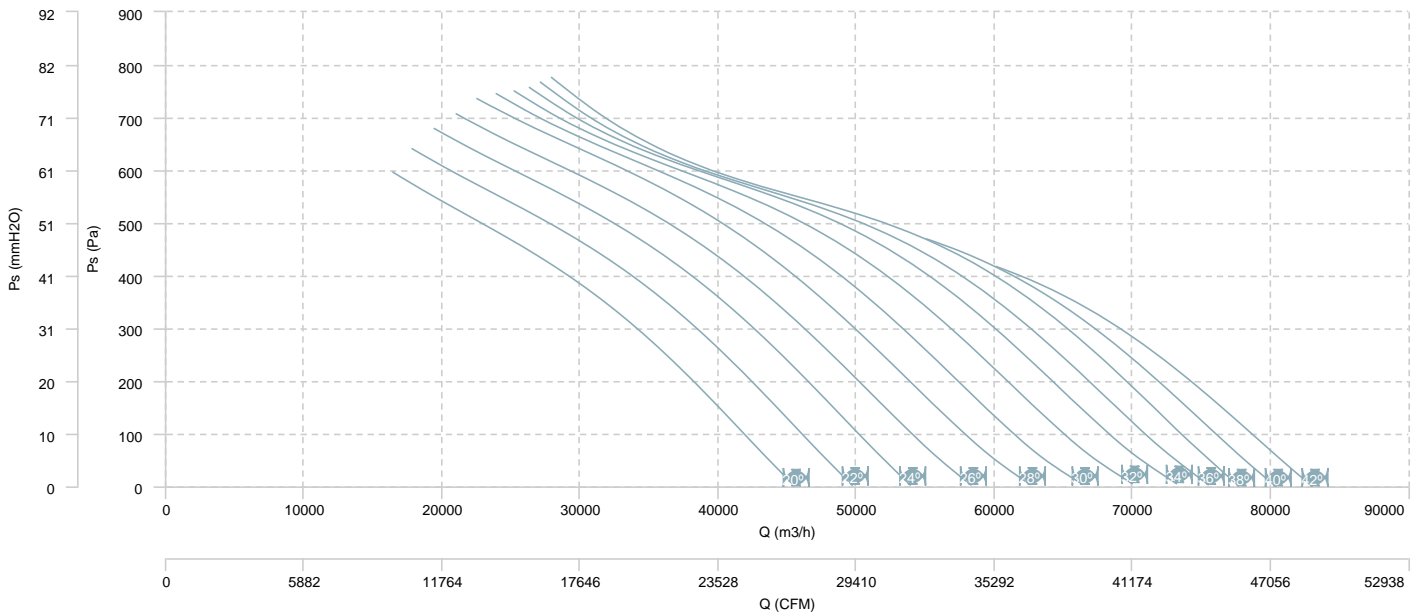

CAUDAL-POTENCIA MECÁNICA

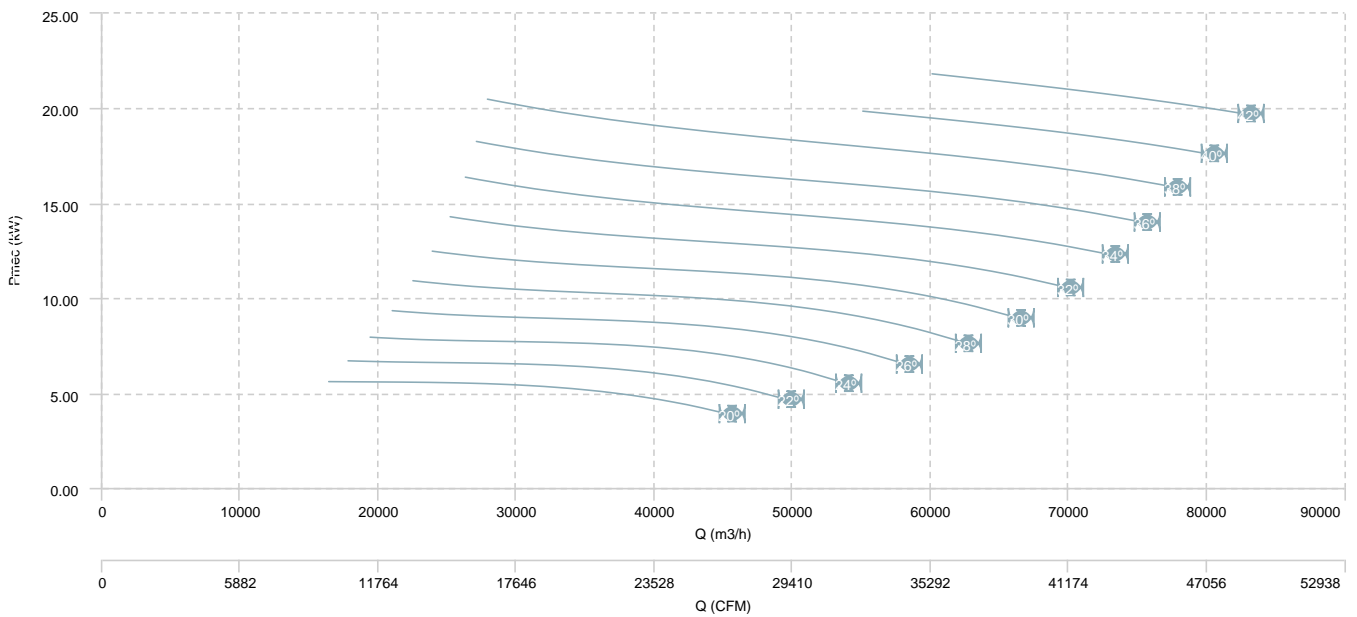

BOX HB 100 T4 (A6:6)

CAUDAL-PRESIÓN

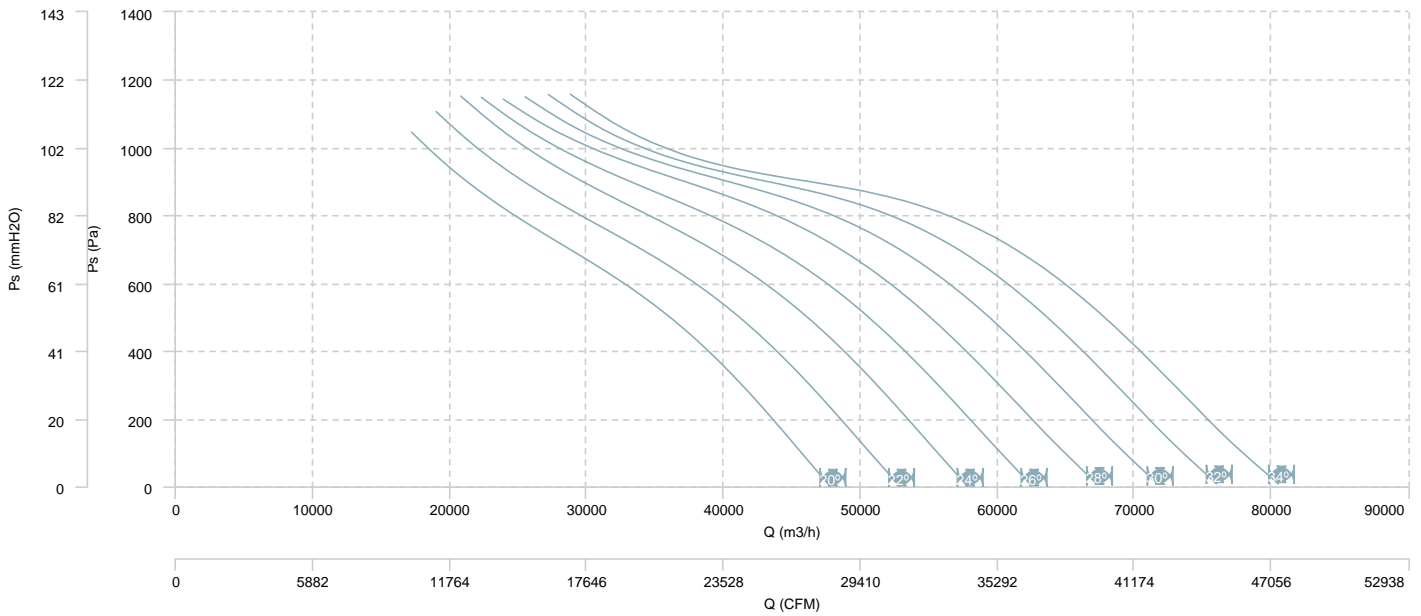

CAUDAL-POTENCIA MECÁNICA

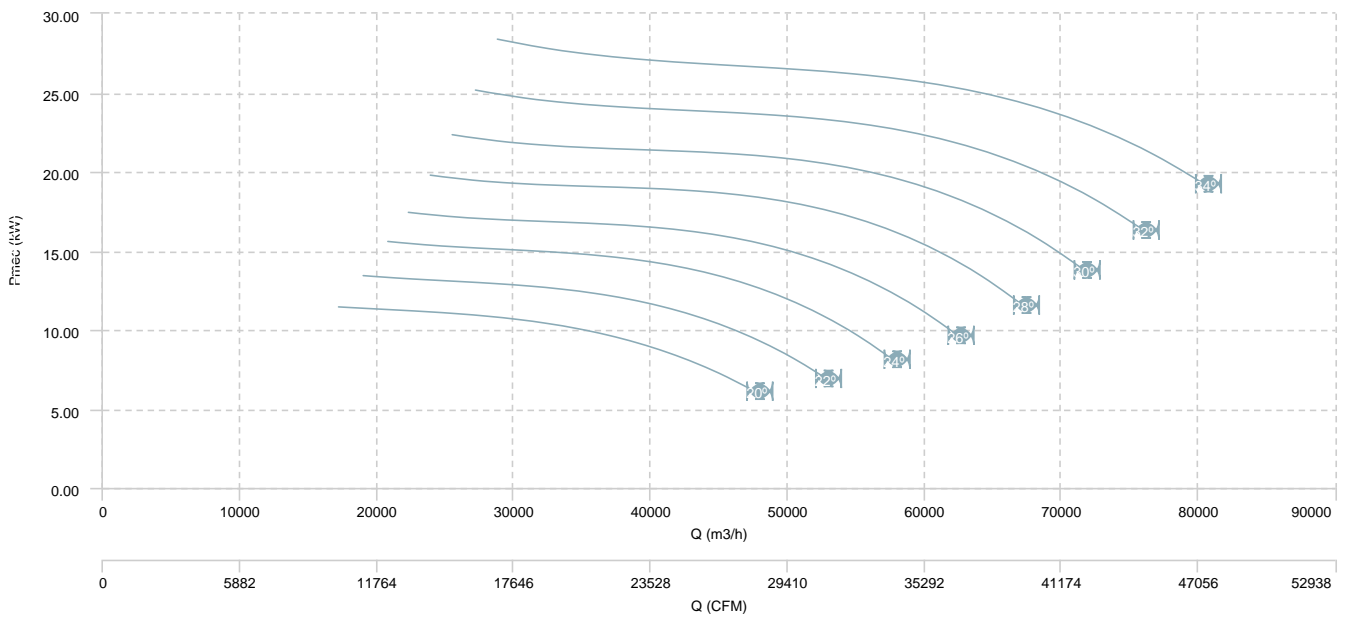

BOX HB 100 T6 (A6:3)

CAUDAL-PRESIÓN

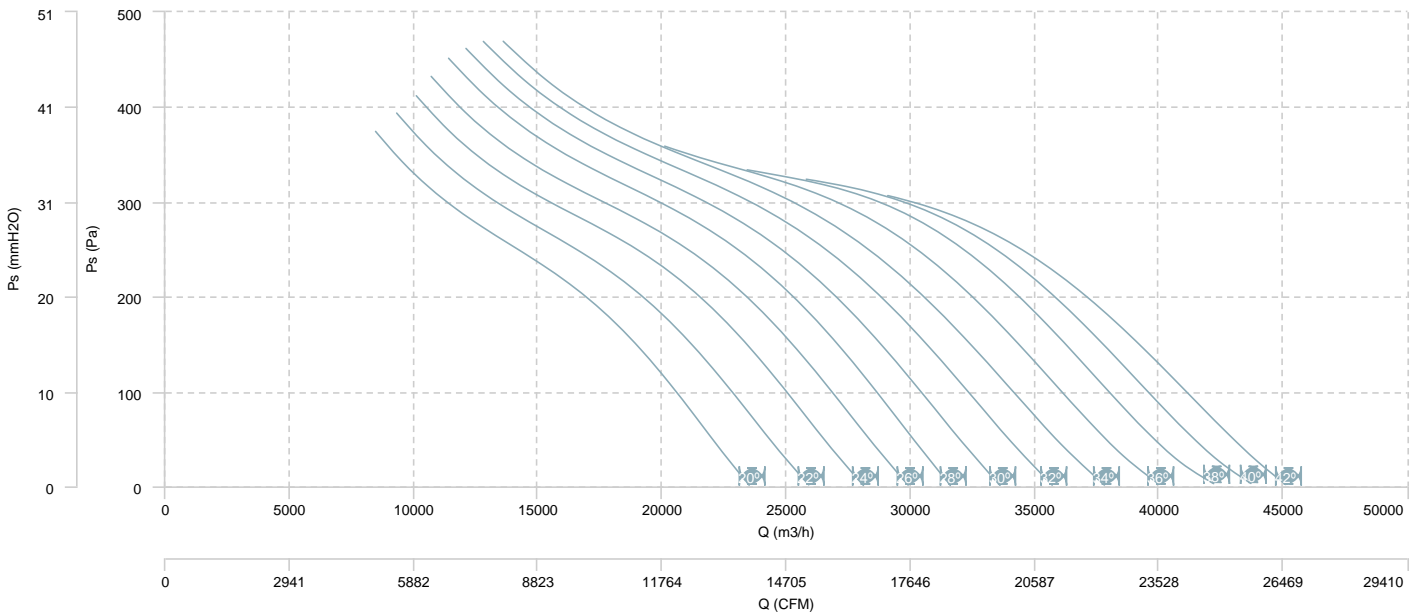

CAUDAL-POTENCIA MECÁNICA

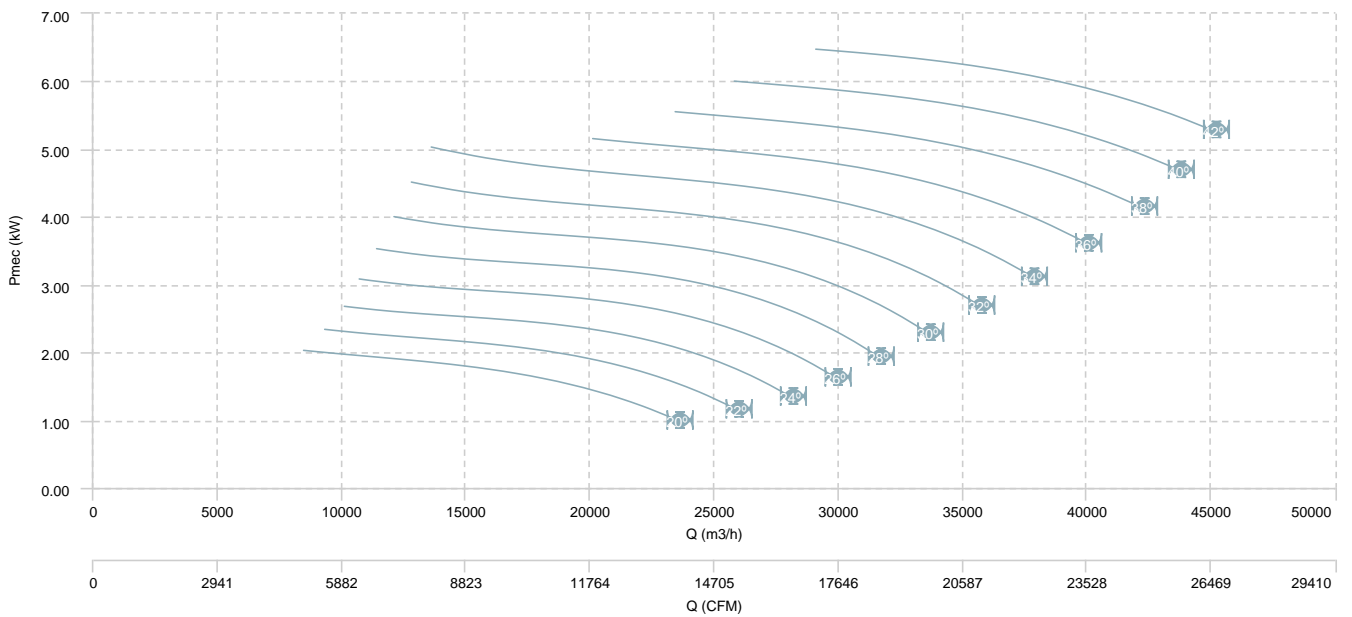

BOX HB 100 T6 (A6:6)

CAUDAL-PRESIÓN

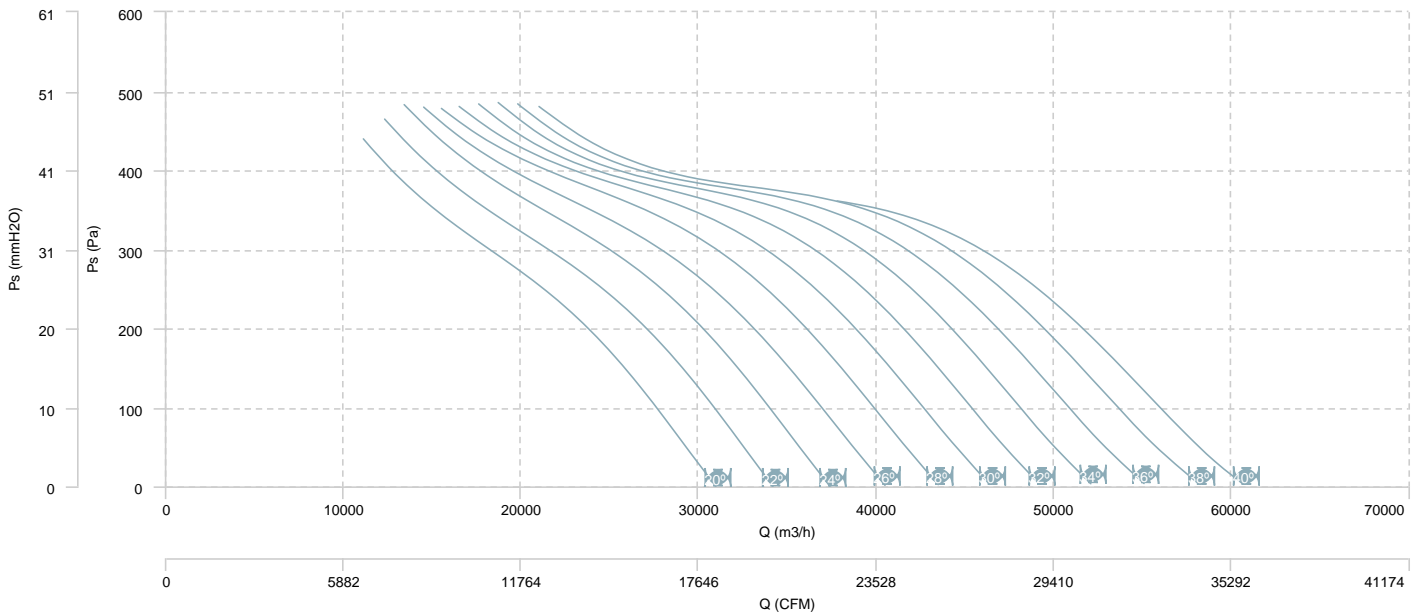

CAUDAL-POTENCIA MECÁNICA

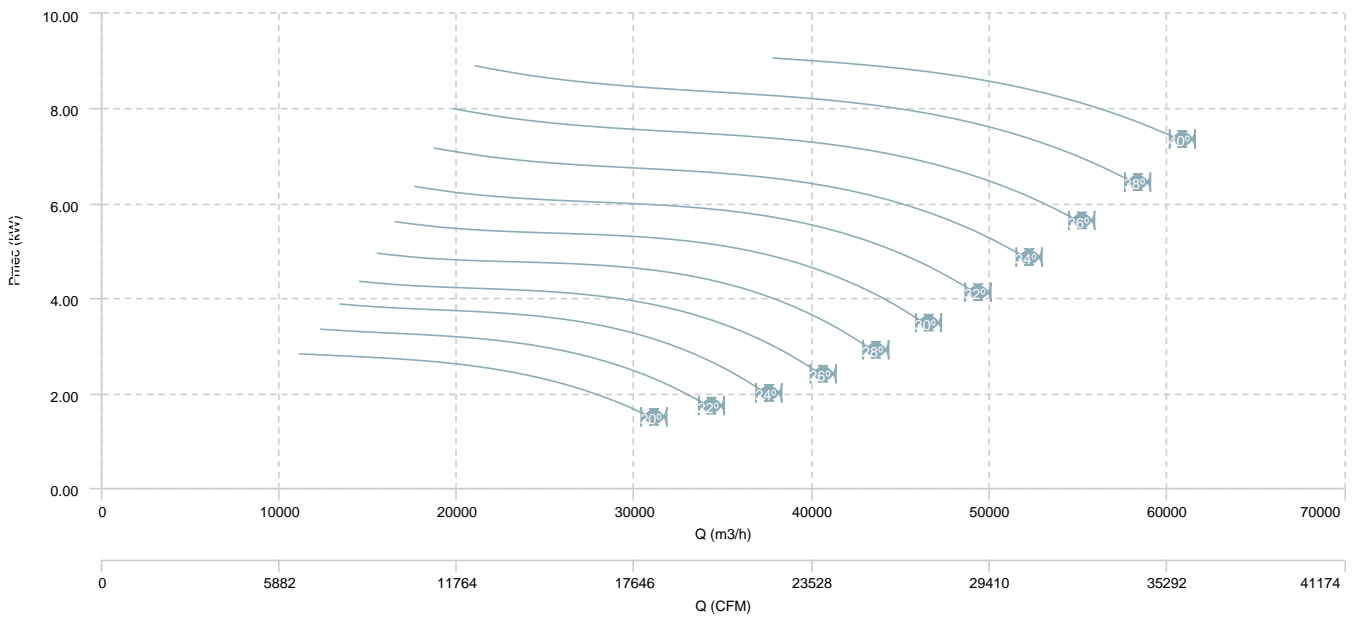

BOX HB 112 T4 (A6:3)

CAUDAL-PRESIÓN

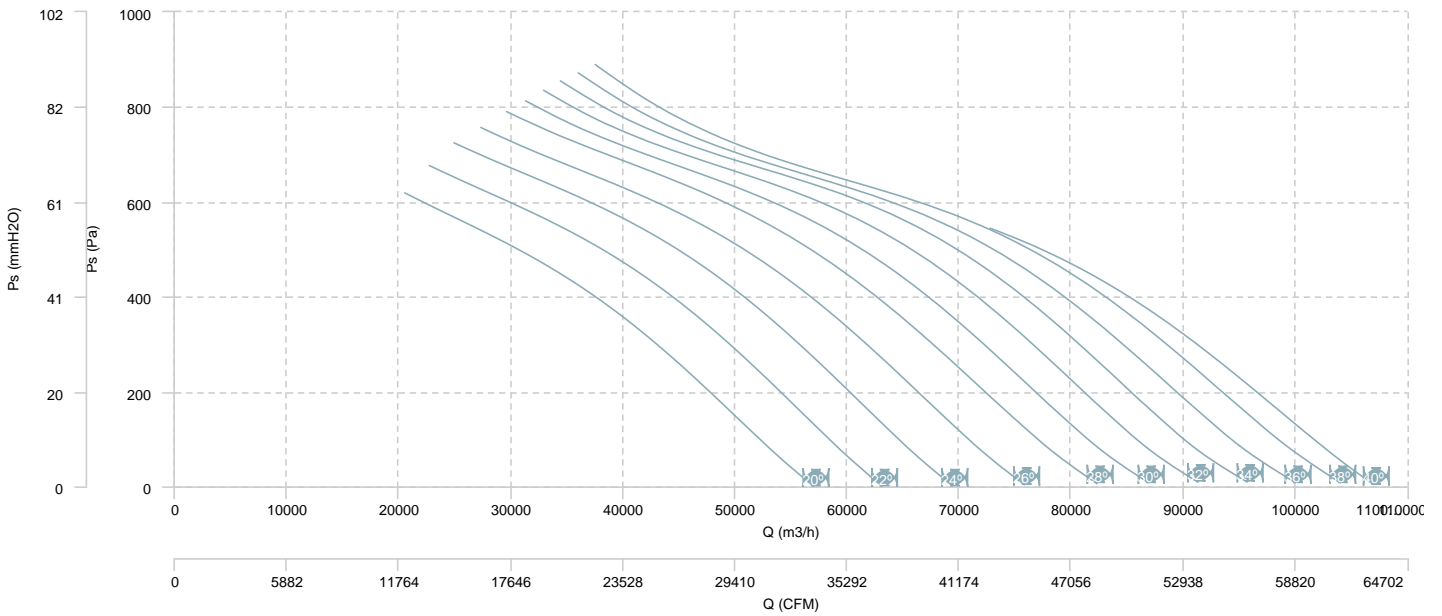

CAUDAL-POTENCIA MECÁNICA

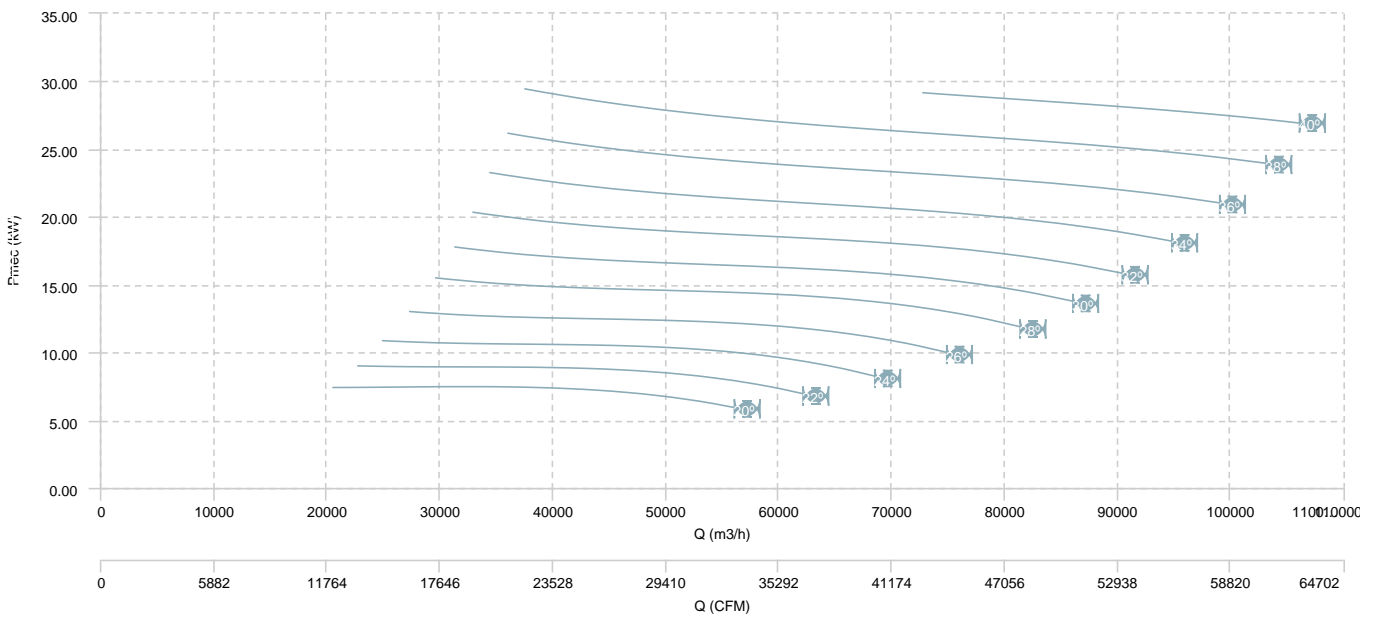

BOX HB 112 T4 (A6:6)

CAUDAL-PRESIÓN

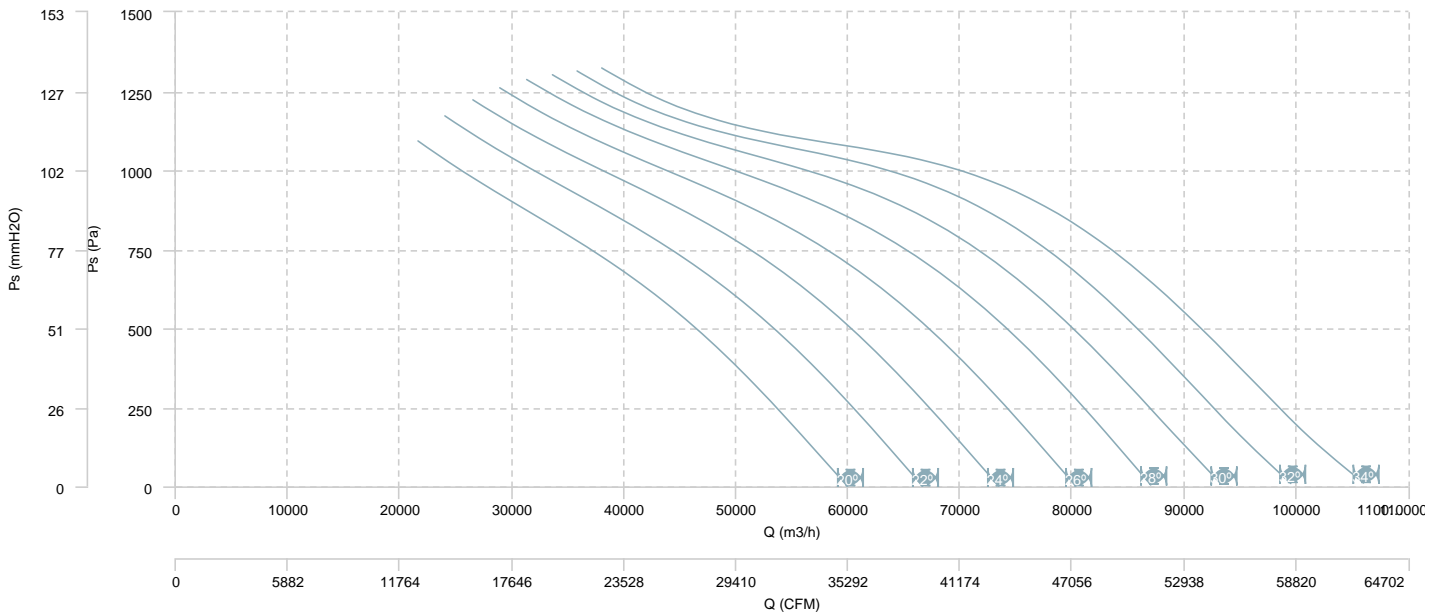

CAUDAL-POTENCIA MECÁNICA

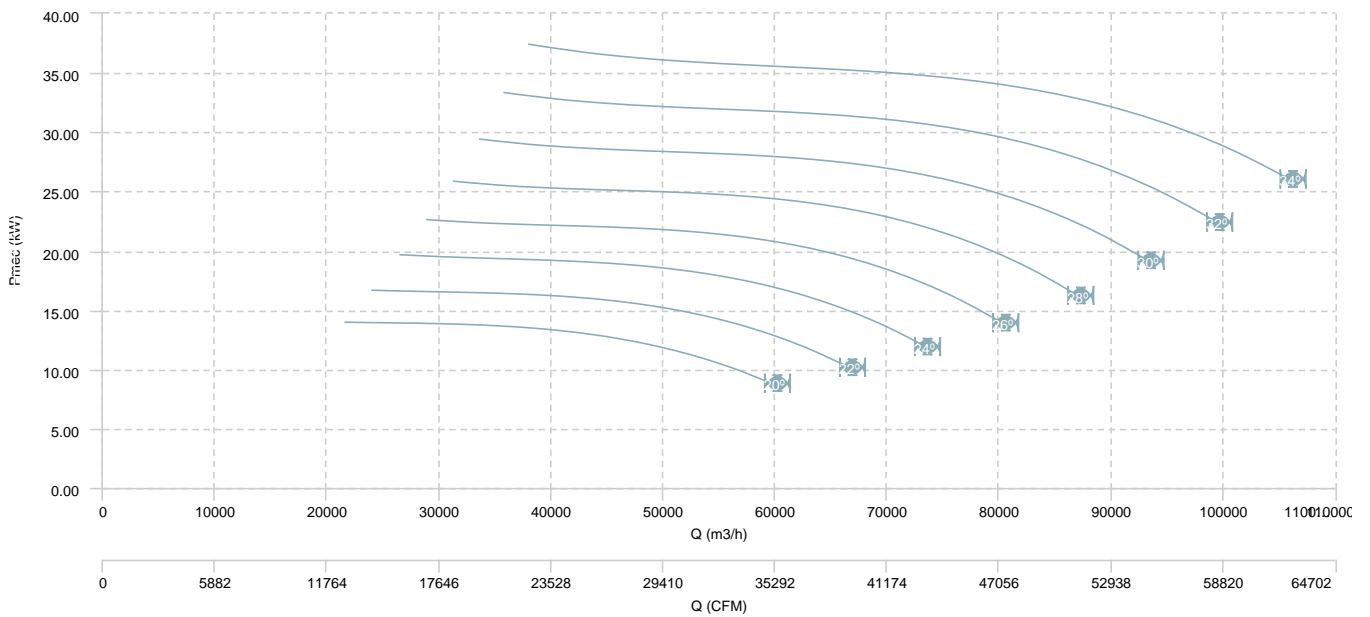

BOX HB 112 T6 (A6:3)

CAUDAL-PRESIÓN

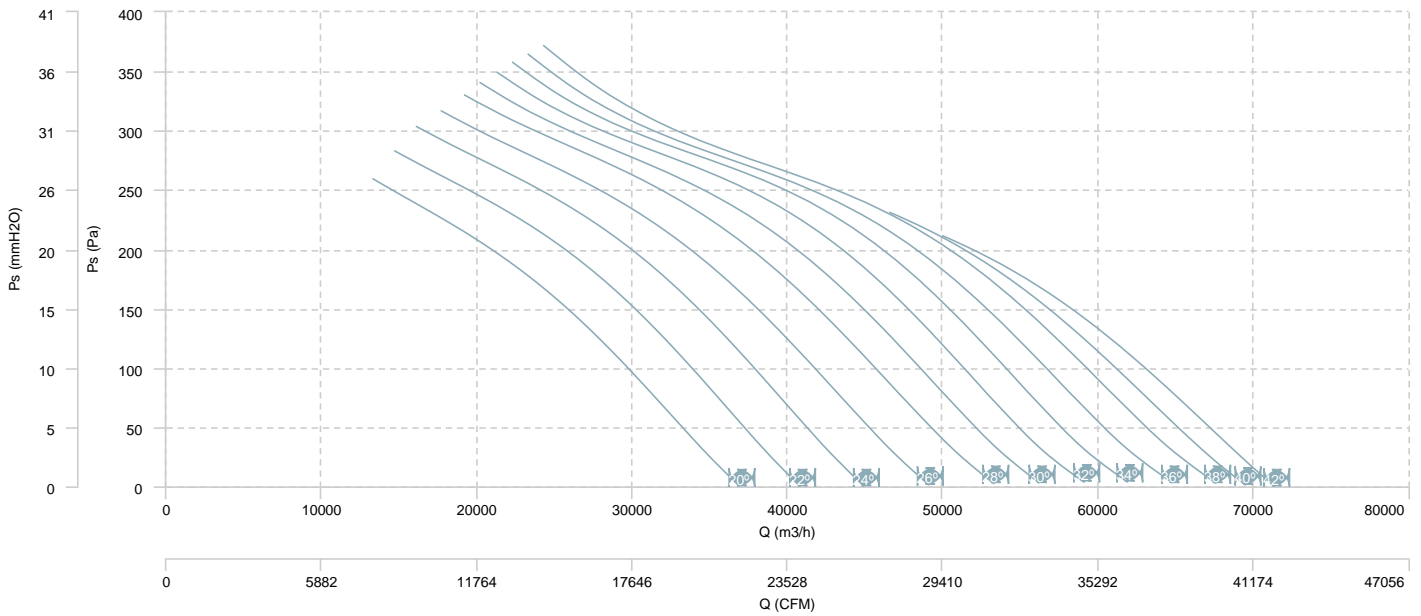

CAUDAL-POTENCIA MECÁNICA

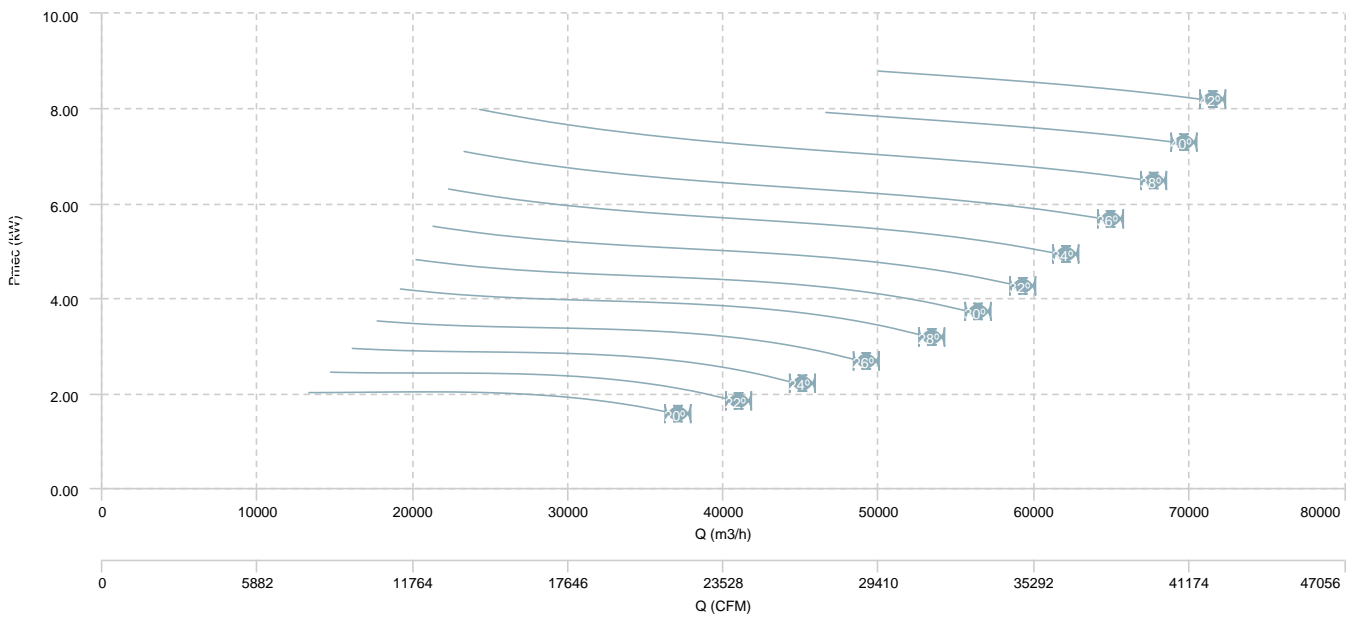

BOX HB 112 T6 (A6:6)

CAUDAL-PRESIÓN

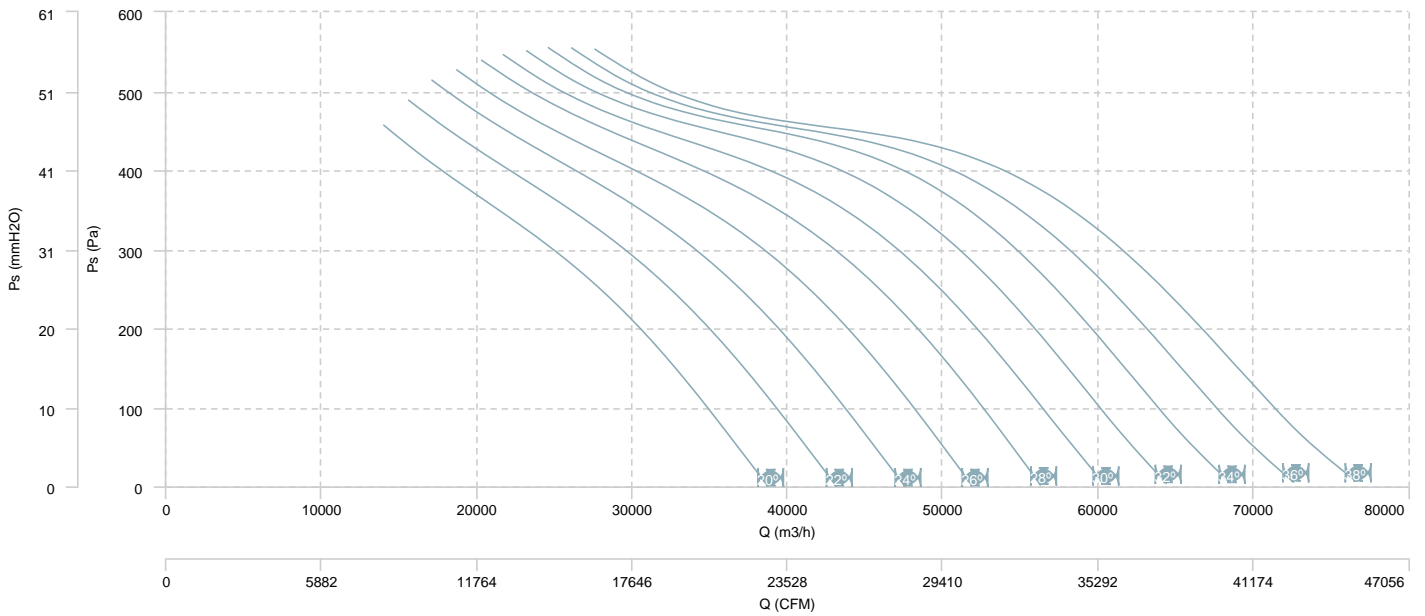

CAUDAL-POTENCIA MECÁNICA

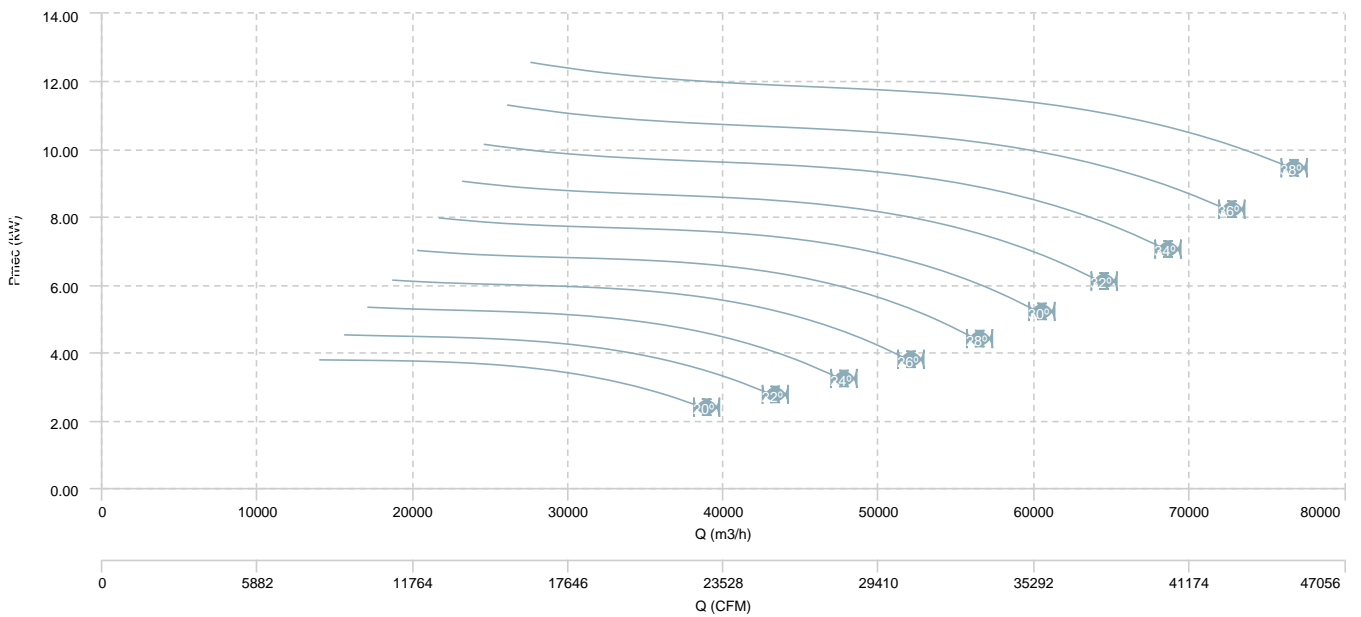

BOX HB 125 T4 (A7:4)

CAUDAL-PRESIÓN

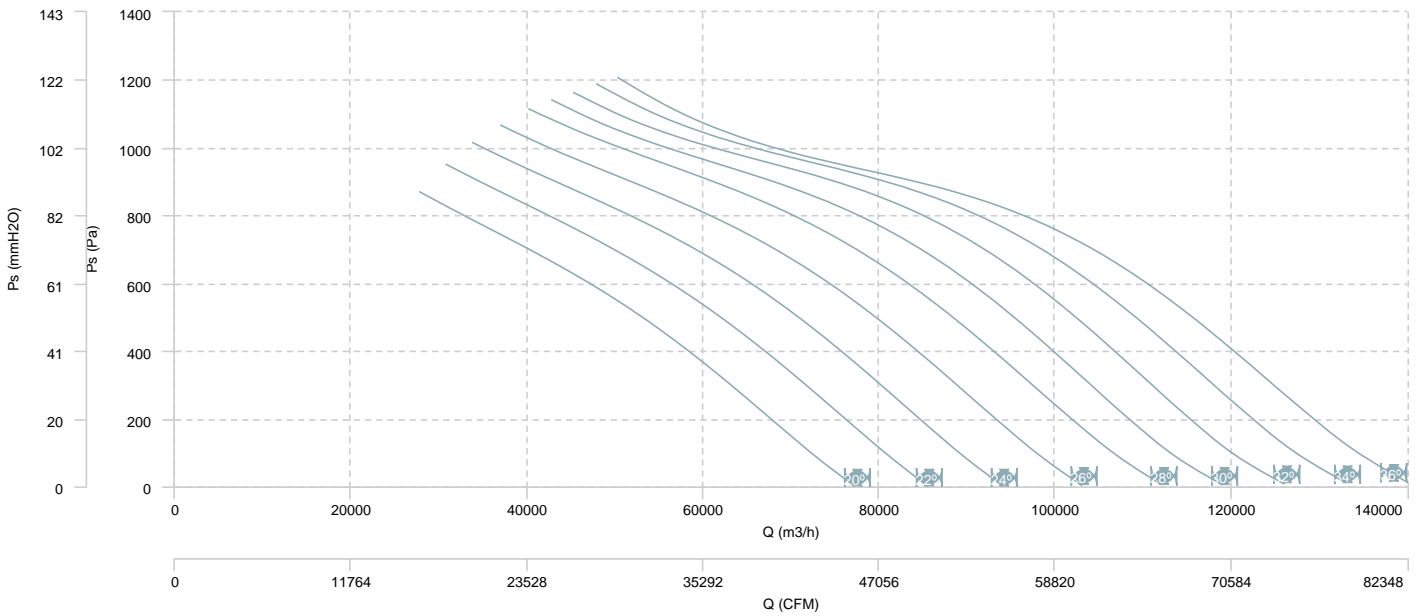

CAUDAL-POTENCIA MECÁNICA

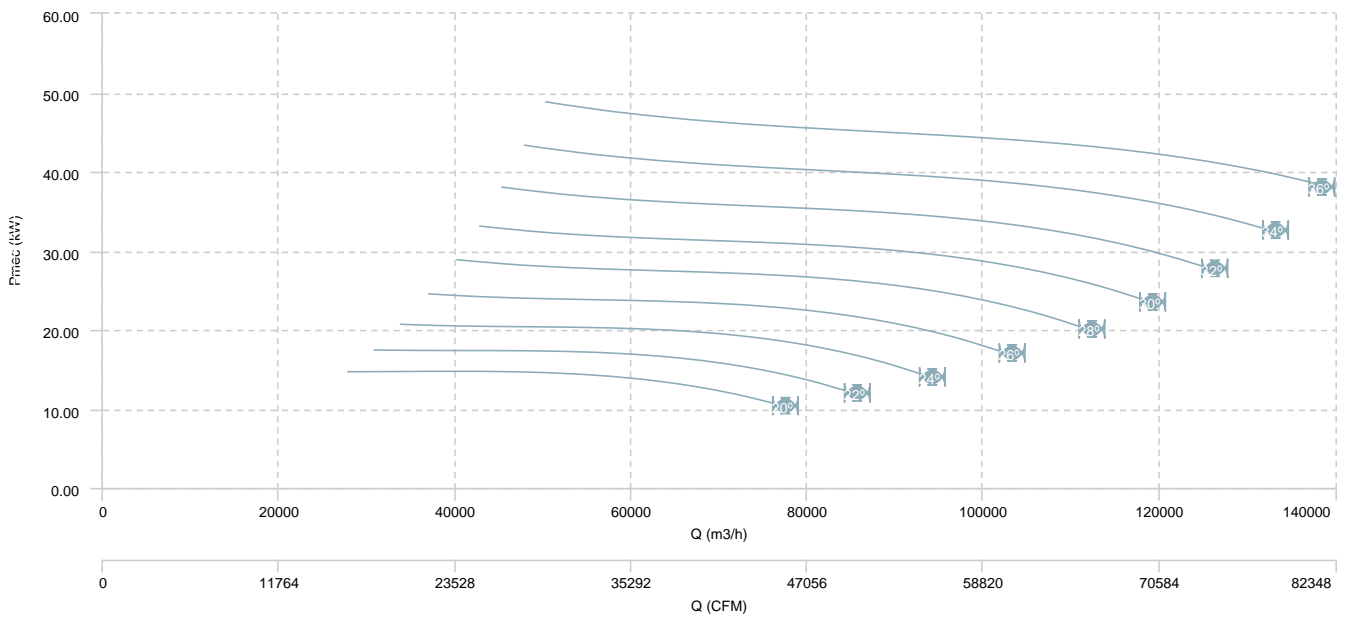

BOX HB 125 T4 (A7:8)

CAUDAL-PRESIÓN

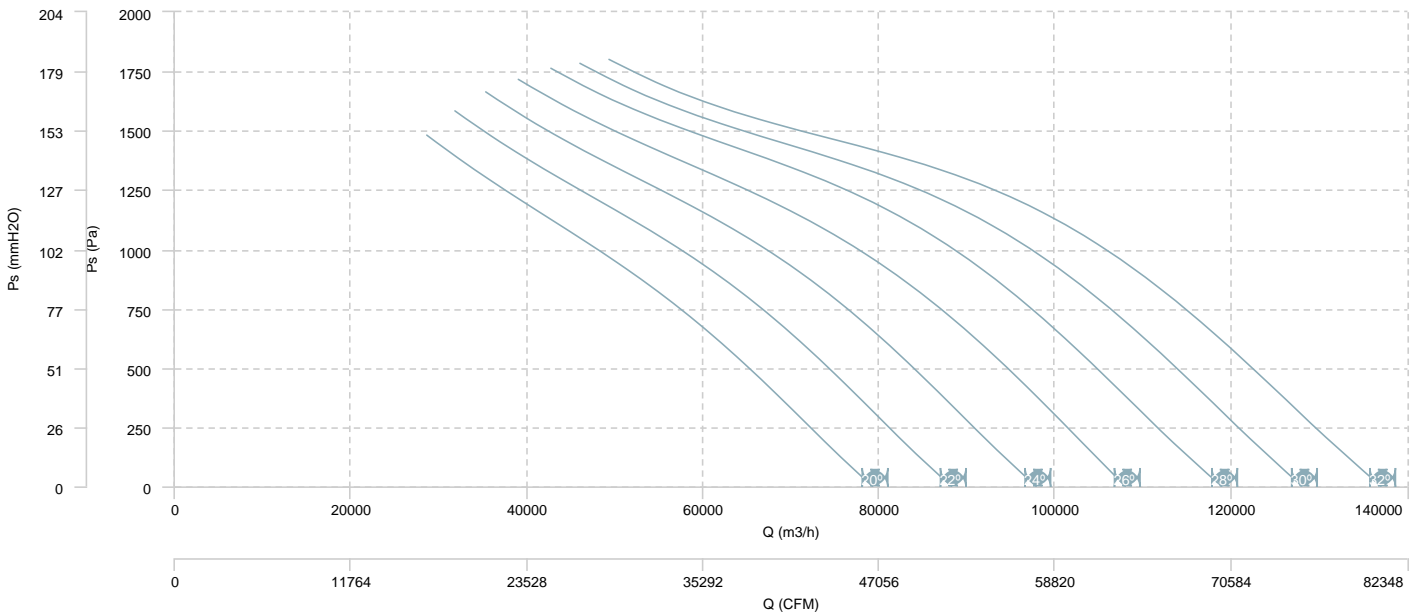

CAUDAL-POTENCIA MECÁNICA

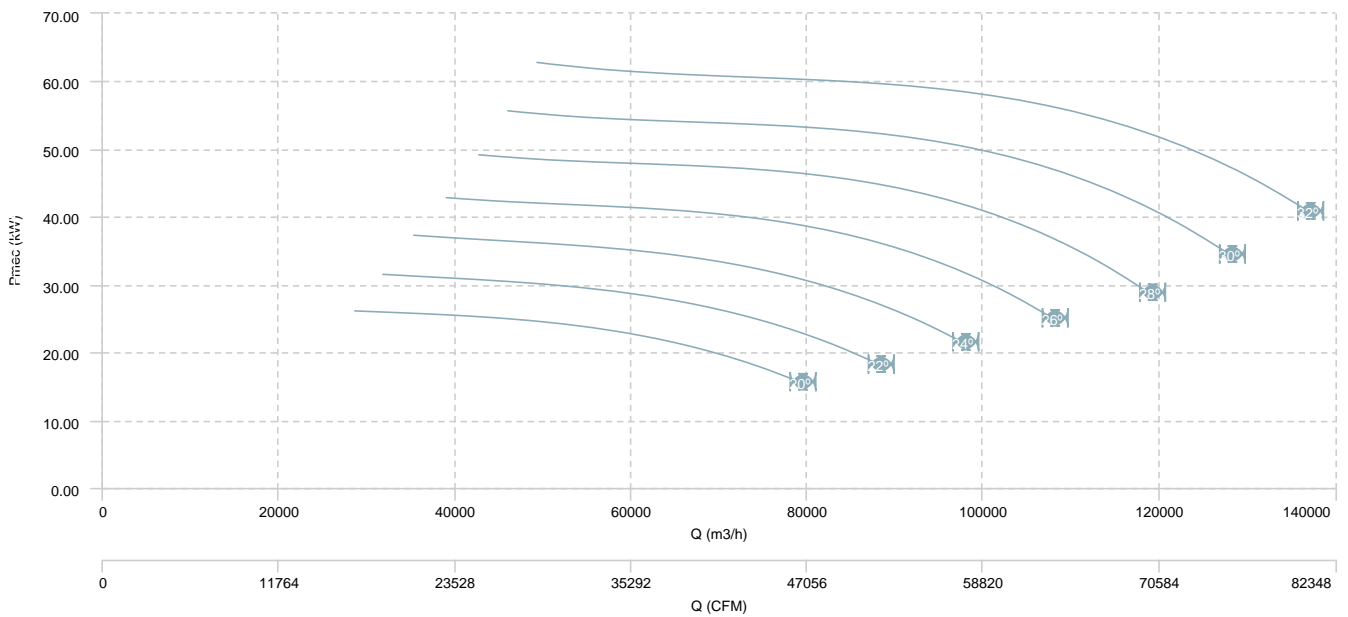

BOX HB 125 T6 (A7:4)

CAUDAL-PRESIÓN

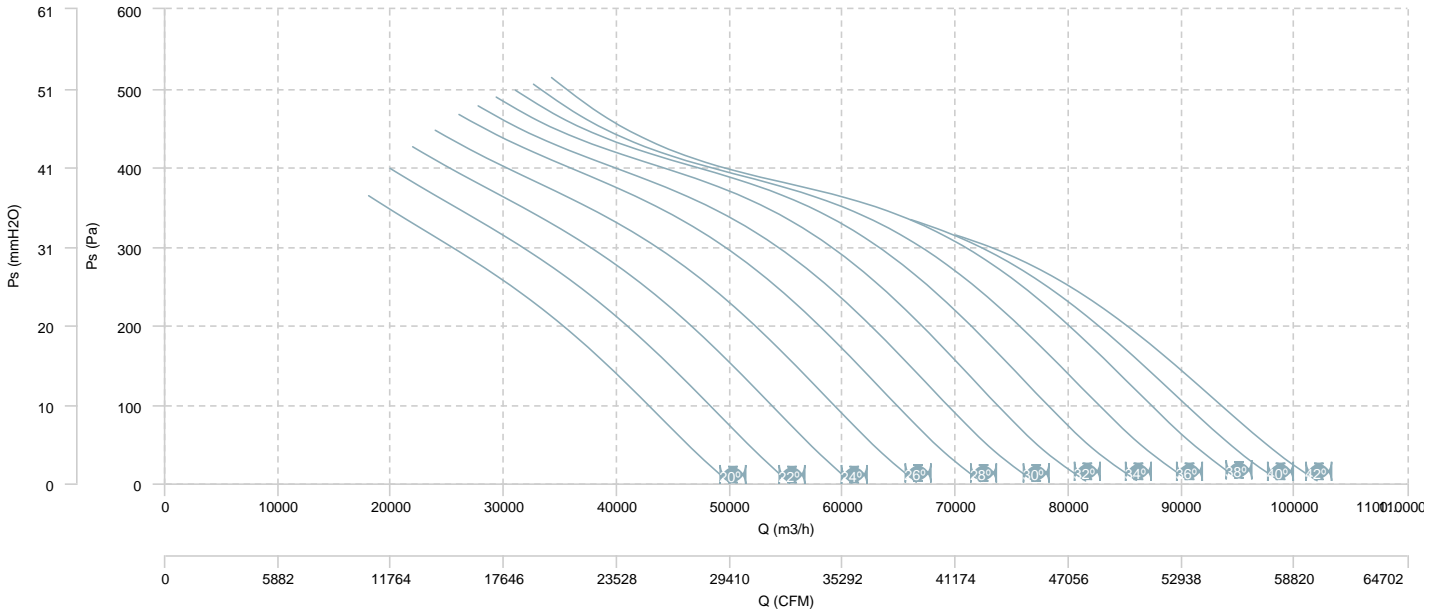

CAUDAL-POTENCIA MECÁNICA

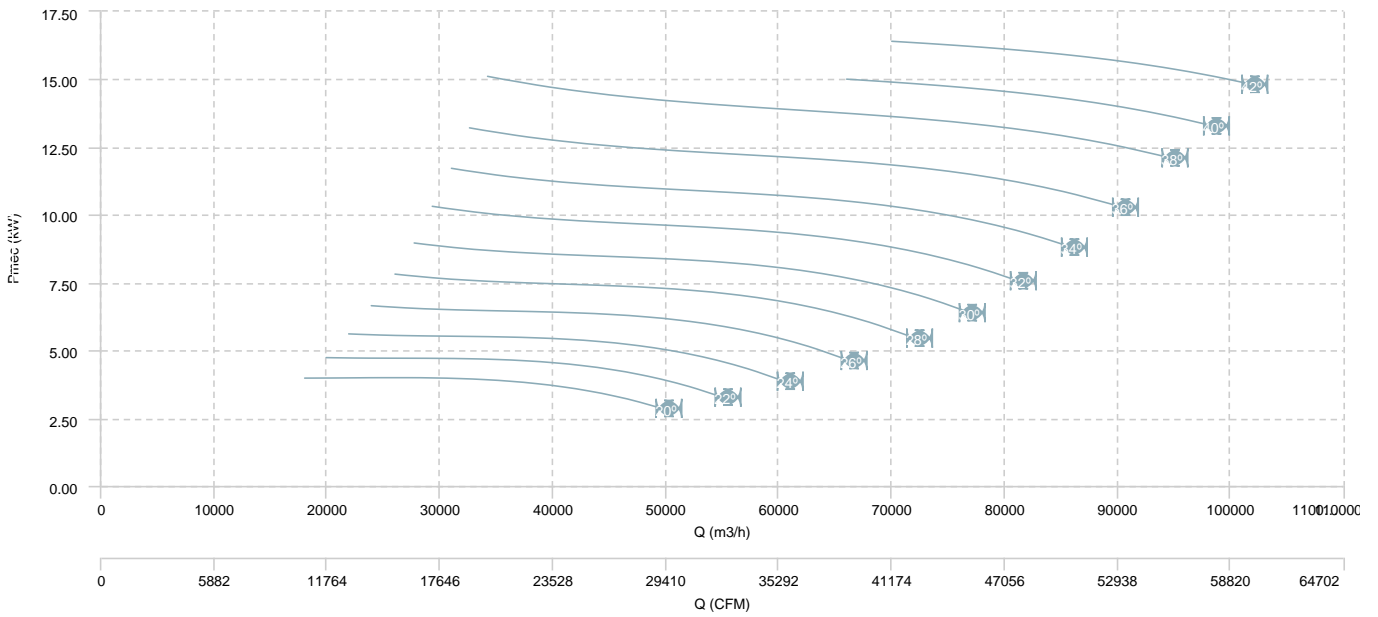

BOX HB 125 T6 (A7:8)

CAUDAL-PRESIÓN

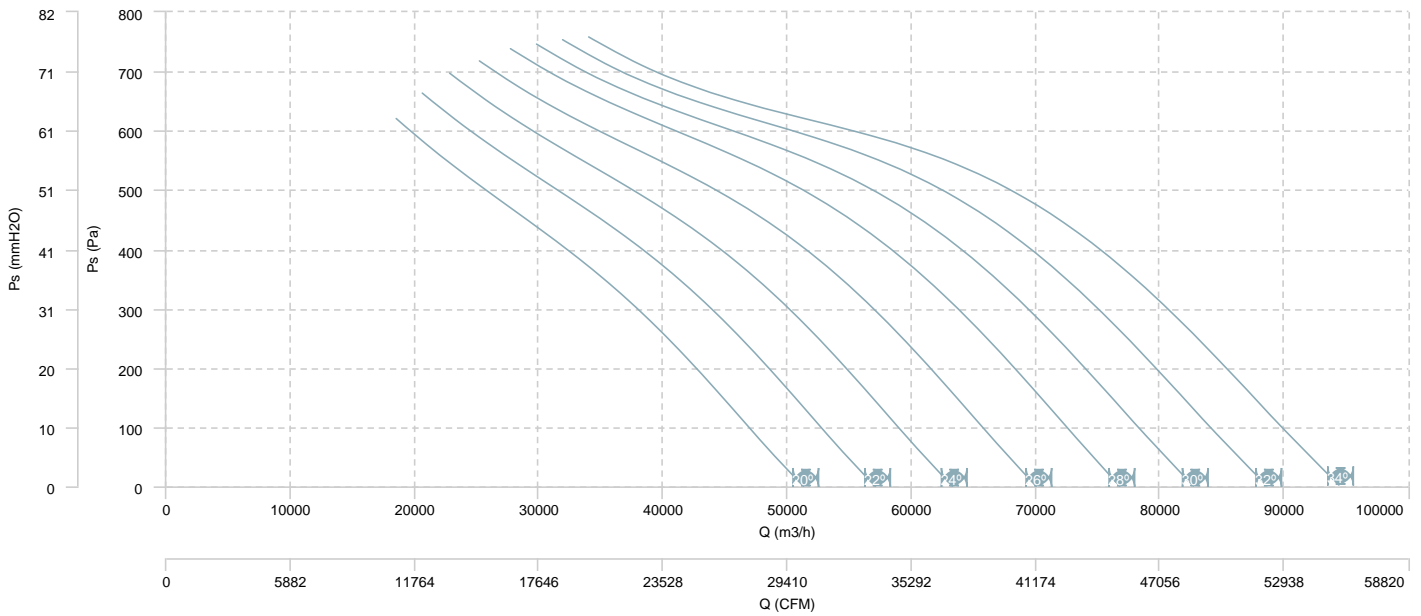

CAUDAL-POTENCIA MECÁNICA

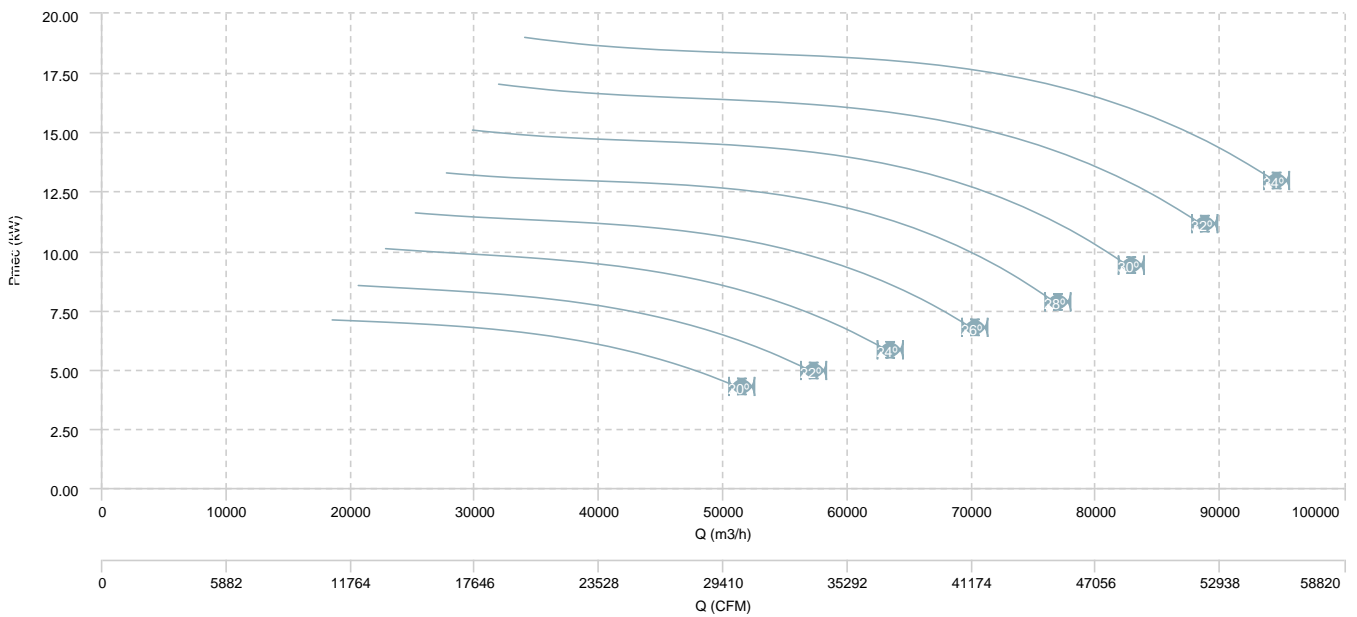

Datos de sonido

sonido / 4 polos

Potencia sonora Lw dB (A)										
Modelo		63 Hz	125 Hz	250 Hz	500 Hz	1000 Hz	2000 Hz	4000 Hz	8000 Hz	Total
BOX HB 45 M4 (A0:6) (25º)	Aspiración	71	70	68	70	71	70	71	69	79
BOX HB 45 M4 (A0:6) (30º)	Aspiración	76	73	71	71	72	71	73	70	81
BOX HB 45 T4 (A0:6) (25º)	Aspiración	71	70	68	70	71	70	71	69	79
BOX HB 45 T4 (A0:6) (30º)	Aspiración	76	73	71	71	72	71	73	70	81
BOX HB 50 M4 (A0:6) (25º)	Aspiración	76	74	74	75	78	78	78	75	85
BOX HB 50 M4 (A0:6) (30º)	Aspiración	77	74	74	73	74	74	74	71	83
BOX HB 50 T4 (A0:6) (25º)	Aspiración	76	74	74	75	78	78	78	75	85
BOX HB 50 T4 (A0:6) (30º)	Aspiración	77	74	74	73	74	74	74	71	83
BOX HB 56 M4 (A2:6) (20º)	Aspiración	47	55	65	74	76	76	77	73	82
BOX HB 56 M4 (A2:6) (25º)	Aspiración	51	58	66	74	76	77	78	73	83
BOX HB 56 M4 (A2:9) (20º)	Aspiración	54	59	68	74	77	77	78	70	83
BOX HB 56 M4 (A5:6) (20º)	Aspiración	68	75	80	81	82	80	78	70	88
BOX HB 56 M4 (A5:6) (25º)	Aspiración	55	64	69	75	77	77	78	69	83
BOX HB 56 T4 (A2:6) (20º)	Aspiración	47	55	65	74	76	76	77	73	82
BOX HB 56 T4 (A2:6) (25º)	Aspiración	51	58	66	74	76	77	78	73	83
BOX HB 56 T4 (A2:6) (27º)	Aspiración	51	59	66	73	75	76	77	72	82
BOX HB 56 T4 (A2:6) (30º)	Aspiración	52	59	66	72	74	75	76	71	81
BOX HB 56 T4 (A2:6) (33º)	Aspiración	53	60	65	72	74	75	76	71	81
BOX HB 56 T4 (A2:6) (35º)	Aspiración	53	60	65	72	73	76	76	71	81
BOX HB 56 T4 (A2:6) (37º)	Aspiración	54	61	66	72	74	76	77	71	82
BOX HB 56 T4 (A2:6) (40º)	Aspiración	55	62	67	72	74	76	77	70	82
BOX HB 56 T4 (A2:6) (43º)	Aspiración	56	61	68	73	75	77	77	71	83
BOX HB 56 T4 (A2:6) (45º)	Aspiración	57	61	69	73	76	77	77	72	83
BOX HB 56 T4 (A2:9) (20º)	Aspiración	54	59	68	74	77	77	78	70	83
BOX HB 56 T4 (A2:9) (25º)	Aspiración	54	59	68	74	77	77	78	71	83
BOX HB 56 T4 (A2:9) (27º)	Aspiración	54	59	68	74	77	77	78	72	83
BOX HB 56 T4 (A2:9) (30º)	Aspiración	55	60	68	74	78	78	79	74	84
BOX HB 56 T4 (A2:9) (33º)	Aspiración	54	60	68	74	77	78	79	74	84
BOX HB 56 T4 (A2:9) (35º)	Aspiración	54	60	69	74	77	78	80	74	84
BOX HB 56 T4 (A2:9) (37º)	Aspiración	54	60	69	74	77	78	79	73	84
BOX HB 56 T4 (A2:9) (40º)	Aspiración	54	61	69	74	77	78	79	73	84
BOX HB 56 T4 (A2:9) (43º)	Aspiración	54	61	71	74	77	78	79	73	84
BOX HB 56 T4 (A2:9) (45º)	Aspiración	54	61	72	74	77	78	79	73	84
BOX HB 56 T4 (A5:6) (20º)	Aspiración	68	75	80	81	82	80	78	70	88
BOX HB 56 T4 (A5:6) (25º)	Aspiración	55	64	69	75	77	77	78	69	83

Potencia sonora Lw dB (A)

Modelo		63 Hz	125 Hz	250 Hz	500 Hz	1000 Hz	2000 Hz	4000 Hz	8000 Hz	Total
BOX HB 56 T4 (A5:6) (30º)	Aspiración	64	73	81	83	83	81	79	71	89
BOX HB 56 T4 (A5:6) (35º)	Aspiración	52	64	69	74	76	76	78	69	83
BOX HB 56 T4 (A5:6) (40º)	Aspiración	58	71	81	87	86	80	78	69	90
BOX HB 56 T4 (A5:6) (45º)	Aspiración	62	74	89	95	93	82	78	68	98
BOX HB 63 T4 (A2:6) (20º)	Aspiración	50	52	65	74	74	74	76	71	81
BOX HB 63 T4 (A2:6) (25º)	Aspiración	54	58	68	76	77	78	79	74	84
BOX HB 63 T4 (A2:6) (27º)	Aspiración	54	59	68	76	77	78	79	74	84
BOX HB 63 T4 (A2:6) (30º)	Aspiración	54	61	67	75	76	78	79	74	84
BOX HB 63 T4 (A2:6) (33º)	Aspiración	54	62	67	74	76	78	78	73	83
BOX HB 63 T4 (A2:6) (35º)	Aspiración	54	61	66	73	75	78	78	73	83
BOX HB 63 T4 (A2:6) (37º)	Aspiración	55	62	67	74	76	78	78	73	83
BOX HB 63 T4 (A2:6) (40º)	Aspiración	56	63	68	74	76	78	78	73	84
BOX HB 63 T4 (A2:6) (43º)	Aspiración	58	63	70	75	78	79	79	73	85
BOX HB 63 T4 (A2:6) (45º)	Aspiración	59	63	71	75	79	79	79	73	85
BOX HB 63 T4 (A2:9) (20º)	Aspiración	58	61	72	78	79	78	80	75	86
BOX HB 63 T4 (A2:9) (25º)	Aspiración	58	62	71	77	79	79	81	75	86
BOX HB 63 T4 (A2:9) (27º)	Aspiración	58	62	71	77	79	79	81	76	86
BOX HB 63 T4 (A2:9) (30º)	Aspiración	59	63	71	77	79	80	82	76	87
BOX HB 63 T4 (A2:9) (33º)	Aspiración	58	64	71	78	79	81	82	76	87
BOX HB 63 T4 (A2:9) (35º)	Aspiración	58	64	71	78	80	81	82	76	87
BOX HB 63 T4 (A2:9) (37º)	Aspiración	58	64	70	77	80	81	82	77	87
BOX HB 63 T4 (A2:9) (40º)	Aspiración	58	64	70	77	80	81	81	77	87
BOX HB 63 T4 (A2:9) (43º)	Aspiración	58	65	70	77	79	81	82	76	87
BOX HB 63 T4 (A2:9) (45º)	Aspiración	58	65	70	77	79	81	82	76	86
BOX HB 63 T4 (A5:6) (20º)	Aspiración	71	78	83	84	85	82	81	74	90
BOX HB 63 T4 (A5:6) (25º)	Aspiración	56	65	70	75	79	78	78	72	84
BOX HB 63 T4 (A5:6) (30º)	Aspiración	59	67	77	84	82	81	81	74	89
BOX HB 63 T4 (A5:6) (35º)	Aspiración	55	67	72	76	80	79	81	74	86
BOX HB 63 T4 (A5:6) (40º)	Aspiración	56	68	79	91	88	83	81	73	94
BOX HB 63 T4 (A5:6) (45º)	Aspiración	57	68	84	101	94	86	81	72	102
BOX HB 71 T4 (A2:6) (20º)	Aspiración	56	62	73	80	84	83	85	78	90
BOX HB 71 T4 (A2:6) (25º)	Aspiración	58	64	72	80	82	82	84	78	89
BOX HB 71 T4 (A2:6) (27º)	Aspiración	58	64	72	79	81	82	84	78	88
BOX HB 71 T4 (A2:6) (30º)	Aspiración	59	65	71	78	80	82	82	78	88
BOX HB 71 T4 (A2:6) (33º)	Aspiración	58	65	70	77	79	81	82	76	87
BOX HB 71 T4 (A2:6) (35º)	Aspiración	58	65	70	76	78	80	81	75	86
BOX HB 71 T4 (A2:6) (37º)	Aspiración	59	66	71	77	79	81	81	75	86
BOX HB 71 T4 (A2:6) (40º)	Aspiración	60	67	72	77	80	81	81	75	87
BOX HB 71 T4 (A2:6) (43º)	Aspiración	62	67	74	78	81	81	81	75	87

Potencia sonora Lw dB (A)										
Modelo		63 Hz	125 Hz	250 Hz	500 Hz	1000 Hz	2000 Hz	4000 Hz	8000 Hz	Total
BOX HB 71 T4 (A2:6) (45º)	Aspiración	63	67	75	78	81	81	81	75	87
BOX HB 71 T4 (A2:9) (20º)	Aspiración	61	67	76	84	86	86	87	80	92
BOX HB 71 T4 (A2:9) (25º)	Aspiración	61	67	75	82	84	84	86	80	91
BOX HB 71 T4 (A2:9) (27º)	Aspiración	61	67	74	81	84	84	86	80	90
BOX HB 71 T4 (A2:9) (30º)	Aspiración	61	68	73	80	83	83	85	79	90
BOX HB 71 T4 (A2:9) (33º)	Aspiración	61	68	73	80	83	84	84	79	90
BOX HB 71 T4 (A2:9) (35º)	Aspiración	61	68	73	80	83	84	84	78	90
BOX HB 71 T4 (A2:9) (37º)	Aspiración	61	68	73	80	83	84	84	79	90
BOX HB 71 T4 (A2:9) (40º)	Aspiración	62	69	74	79	83	84	84	79	90
BOX HB 71 T4 (A2:9) (43º)	Aspiración	61	69	74	79	82	84	84	78	89
BOX HB 71 T4 (A2:9) (45º)	Aspiración	61	68	74	79	82	83	83	77	89
BOX HB 71 T4 (A5:6) (20º)	Aspiración	73	80	85	87	87	85	84	77	93
BOX HB 71 T4 (A5:6) (25º)	Aspiración	60	70	76	80	83	84	84	75	89
BOX HB 71 T4 (A5:6) (30º)	Aspiración	62	70	76	82	83	83	82	73	89
BOX HB 71 T4 (A5:6) (35º)	Aspiración	54	66	71	76	79	80	81	72	86
BOX HB 71 T4 (A5:6) (40º)	Aspiración	59	69	84	94	90	85	83	73	96
BOX HB 71 T4 (A5:6) (45º)	Aspiración	62	71	93	106	97	88	84	74	107
BOX HB 80 T4 (A2:6) (20º)	Aspiración	55	62	72	80	84	83	85	80	90
BOX HB 80 T4 (A2:6) (25º)	Aspiración	58	65	73	80	83	84	85	80	90
BOX HB 80 T4 (A2:6) (27º)	Aspiración	59	66	73	80	83	84	85	80	90
BOX HB 80 T4 (A2:6) (30º)	Aspiración	61	68	73	80	83	84	85	79	90
BOX HB 80 T4 (A2:6) (33º)	Aspiración	62	69	74	80	83	85	85	78	90
BOX HB 80 T4 (A2:6) (35º)	Aspiración	63	70	75	79	82	85	85	78	90
BOX HB 80 T4 (A2:6) (37º)	Aspiración	63	70	75	79	82	84	84	77	89
BOX HB 80 T4 (A2:6) (40º)	Aspiración	62	70	75	79	82	83	83	76	89
BOX HB 80 T4 (A2:6) (43º)	Aspiración	63	70	76	80	83	83	83	76	89
BOX HB 80 T4 (A2:6) (45º)	Aspiración	63	70	76	80	83	83	83	76	89
BOX HB 80 T4 (A2:9) (20º)	Aspiración	60	73	78	90	92	90	93	85	98
BOX HB 80 T4 (A2:9) (25º)	Aspiración	63	72	77	87	90	89	91	84	96
BOX HB 80 T4 (A2:9) (27º)	Aspiración	63	72	77	87	89	89	90	84	95
BOX HB 80 T4 (A2:9) (30º)	Aspiración	64	71	76	85	88	88	89	83	94
BOX HB 80 T4 (A2:9) (33º)	Aspiración	64	71	76	84	87	88	88	82	93
BOX HB 80 T4 (A2:9) (35º)	Aspiración	63	70	75	82	86	88	87	81	93
BOX HB 80 T4 (A2:9) (37º)	Aspiración	64	71	76	82	86	87	87	81	92
BOX HB 80 T4 (A2:9) (40º)	Aspiración	65	72	77	82	85	87	86	80	92
BOX HB 80 T4 (A2:9) (43º)	Aspiración	65	72	78	82	85	86	85	79	91
BOX HB 80 T4 (A2:9) (45º)	Aspiración	65	72	78	82	85	86	85	79	91
BOX HB 80 T4 (A5:6) (20º)	Aspiración	76	83	88	90	90	88	87	80	96
BOX HB 80 T4 (A5:6) (25º)	Aspiración	63	70	76	81	83	83	84	76	89

Potencia sonora Lw dB (A)										
Modelo		63 Hz	125 Hz	250 Hz	500 Hz	1000 Hz	2000 Hz	4000 Hz	8000 Hz	Total
BOX HB 80 T4 (A5:6) (30º)	Aspiración	63	74	81	91	89	87	87	79	95
BOX HB 80 T4 (A5:6) (35º)	Aspiración	60	72	78	86	91	89	89	80	95
BOX HB 80 T4 (A5:6) (40º)	Aspiración	61	74	90	95	92	88	86	78	98
BOX HB 80 T4 (A5:6) (45º)	Aspiración	61	75	98	101	93	87	84	76	103
BOX HB 90 T4 (A6:3) (20º)	Aspiración	61	64	73	76	80	81	85	79	88
BOX HB 90 T4 (A6:3) (22º)	Aspiración	62	66	74	78	82	83	86	80	89
BOX HB 90 T4 (A6:3) (24º)	Aspiración	63	68	75	80	83	84	87	81	91
BOX HB 90 T4 (A6:3) (26º)	Aspiración	64	69	76	82	84	85	87	82	92
BOX HB 90 T4 (A6:3) (28º)	Aspiración	65	70	77	83	85	86	88	82	93
BOX HB 90 T4 (A6:3) (30º)	Aspiración	66	72	78	85	86	87	89	83	94
BOX HB 90 T4 (A6:3) (32º)	Aspiración	66	72	79	86	87	88	89	84	94
BOX HB 90 T4 (A6:3) (34º)	Aspiración	66	73	79	88	88	89	90	84	95
BOX HB 90 T4 (A6:3) (36º)	Aspiración	67	73	80	89	88	90	90	85	96
BOX HB 90 T4 (A6:3) (38º)	Aspiración	67	74	81	90	90	91	91	86	97
BOX HB 90 T4 (A6:3) (40º)	Aspiración	67	75	82	90	91	92	92	87	98
BOX HB 90 T4 (A6:3) (42º)	Aspiración	68	76	83	91	92	93	93	87	99
BOX HB 90 T4 (A6:6) (20º)	Aspiración	66	76	82	89	93	91	92	87	99
BOX HB 90 T4 (A6:6) (22º)	Aspiración	67	76	82	90	93	92	92	87	99
BOX HB 90 T4 (A6:6) (24º)	Aspiración	68	77	83	90	93	92	93	88	99
BOX HB 90 T4 (A6:6) (26º)	Aspiración	68	78	83	91	93	92	93	89	100
BOX HB 90 T4 (A6:6) (28º)	Aspiración	69	78	84	91	93	93	94	89	100
BOX HB 90 T4 (A6:6) (30º)	Aspiración	70	79	84	91	93	93	94	89	100
BOX HB 90 T4 (A6:6) (32º)	Aspiración	68	78	83	90	91	91	93	88	98
BOX HB 90 T4 (A6:6) (34º)	Aspiración	67	76	81	88	89	90	92	86	96
BOX HB 90 T4 (A6:6) (36º)	Aspiración	67	76	81	87	88	89	91	86	96
BOX HB 90 T4 (A6:6) (38º)	Aspiración	68	77	82	88	89	90	92	86	97
BOX HB 90 T4 (A6:6) (40º)	Aspiración	68	77	82	89	90	91	92	86	97
BOX HB 90 T4 (A6:6) (42º)	Aspiración	69	78	83	89	90	91	92	86	98
BOX HB 100 T4 (A6:3) (20º)	Aspiración	65	72	77	82	88	89	93	85	96
BOX HB 100 T4 (A6:3) (22º)	Aspiración	66	73	78	83	88	89	93	86	96
BOX HB 100 T4 (A6:3) (24º)	Aspiración	66	73	78	84	88	89	92	86	96
BOX HB 100 T4 (A6:3) (26º)	Aspiración	66	73	78	84	88	89	91	85	95
BOX HB 100 T4 (A6:3) (28º)	Aspiración	67	73	79	84	87	88	91	85	95
BOX HB 100 T4 (A6:3) (30º)	Aspiración	67	73	79	85	87	88	90	84	94
BOX HB 100 T4 (A6:3) (32º)	Aspiración	68	74	80	86	88	89	91	85	96
BOX HB 100 T4 (A6:3) (34º)	Aspiración	70	75	82	88	90	90	91	86	97
BOX HB 100 T4 (A6:3) (36º)	Aspiración	70	76	83	89	90	91	92	87	98
BOX HB 100 T4 (A6:3) (38º)	Aspiración	70	77	83	90	91	92	92	87	98
BOX HB 100 T4 (A6:3) (40º)	Aspiración	70	77	83	90	92	93	93	88	99

Potencia sonora Lw dB (A)

Modelo		63 Hz	125 Hz	250 Hz	500 Hz	1000 Hz	2000 Hz	4000 Hz	8000 Hz	Total
BOX HB 100 T4 (A6:3) (42º)	Aspiración	70	78	84	91	93	93	94	89	100
BOX HB 100 T4 (A6:6) (20º)	Aspiración	56	63	68	73	78	79	83	76	86
BOX HB 100 T4 (A6:6) (22º)	Aspiración	57	64	69	74	79	80	83	76	87
BOX HB 100 T4 (A6:6) (24º)	Aspiración	57	64	69	75	79	80	83	76	87
BOX HB 100 T4 (A6:6) (26º)	Aspiración	57	64	69	75	78	79	82	76	86
BOX HB 100 T4 (A6:6) (28º)	Aspiración	57	63	69	75	78	79	81	75	85
BOX HB 100 T4 (A6:6) (30º)	Aspiración	57	63	69	75	78	79	80	75	85
BOX HB 100 T4 (A6:6) (32º)	Aspiración	59	65	71	77	79	80	81	76	86
BOX HB 100 T4 (A6:6) (34º)	Aspiración	61	66	73	79	80	81	82	77	87
BOX HB 100 T4 (A6:6) (36º)	Aspiración	61	67	73	80	81	82	82	77	88
BOX HB 100 T4 (A6:6) (38º)	Aspiración	61	67	74	80	82	83	83	78	89
BOX HB 100 T4 (A6:6) (40º)	Aspiración	61	68	74	81	83	83	83	78	89
BOX HB 100 T4 (A6:6) (42º)	Aspiración	61	69	74	81	84	84	84	79	90
BOX HB 112 T4 (A6:3) (20º)	Aspiración	68	75	80	87	92	93	95	90	100
BOX HB 112 T4 (A6:3) (22º)	Aspiración	70	77	82	88	93	94	96	91	100
BOX HB 112 T4 (A6:3) (24º)	Aspiración	71	78	83	89	93	94	96	91	101
BOX HB 112 T4 (A6:3) (26º)	Aspiración	72	78	84	90	93	94	96	91	101
BOX HB 112 T4 (A6:3) (28º)	Aspiración	72	78	84	90	93	94	96	91	101
BOX HB 112 T4 (A6:3) (30º)	Aspiración	72	77	84	90	92	93	96	91	100
BOX HB 112 T4 (A6:3) (32º)	Aspiración	73	78	85	90	93	93	95	91	100
BOX HB 112 T4 (A6:3) (34º)	Aspiración	73	78	86	91	93	93	95	91	100
BOX HB 112 T4 (A6:3) (36º)	Aspiración	74	79	86	91	93	94	95	91	101
BOX HB 112 T4 (A6:3) (38º)	Aspiración	74	79	86	92	94	94	95	91	101
BOX HB 112 T4 (A6:3) (40º)	Aspiración	74	80	86	92	94	95	95	91	101
BOX HB 112 T4 (A6:3) (42º)	Aspiración	74	81	86	93	95	96	96	91	102
BOX HB 112 T4 (A6:6) (20º)	Aspiración	70	81	87	98	100	98	99	94	105
BOX HB 112 T4 (A6:6) (22º)	Aspiración	71	81	87	98	99	98	99	93	105
BOX HB 112 T4 (A6:6) (24º)	Aspiración	72	81	87	96	98	98	99	93	104
BOX HB 112 T4 (A6:6) (26º)	Aspiración	73	82	87	96	98	98	99	93	105
BOX HB 112 T4 (A6:6) (28º)	Aspiración	75	83	88	96	98	98	99	93	105
BOX HB 112 T4 (A6:6) (30º)	Aspiración	76	83	88	95	97	98	99	92	104
BOX HB 112 T4 (A6:6) (32º)	Aspiración	75	82	87	93	96	97	98	91	103
BOX HB 112 T4 (A6:6) (34º)	Aspiración	75	82	87	92	95	96	98	90	102
BOX HB 112 T4 (A6:6) (36º)	Aspiración	76	83	88	92	95	96	98	90	102
BOX HB 112 T4 (A6:6) (38º)	Aspiración	77	84	90	93	96	98	99	91	104
BOX HB 112 T4 (A6:6) (40º)	Aspiración	79	86	91	95	98	99	100	93	105
BOX HB 112 T4 (A6:6) (42º)	Aspiración	79	85	91	95	98	99	99	93	105
BOX HB 125 T4 (A7:4) (20º)	Aspiración	73	86	91	99	103	103	105	102	110
BOX HB 125 T4 (A7:4) (22º)	Aspiración	76	87	92	99	103	103	105	102	110

Potencia sonora Lw dB (A)										
Modelo		63 Hz	125 Hz	250 Hz	500 Hz	1000 Hz	2000 Hz	4000 Hz	8000 Hz	Total
BOX HB 125 T4 (A7:4) (24º)	Aspiración	76	86	91	97	101	102	104	99	108
BOX HB 125 T4 (A7:4) (26º)	Aspiración	77	84	89	95	99	100	102	96	106
BOX HB 125 T4 (A7:4) (28º)	Aspiración	76	83	88	93	98	99	100	94	105
BOX HB 125 T4 (A7:4) (30º)	Aspiración	75	82	87	91	95	97	98	91	103
BOX HB 125 T4 (A7:4) (32º)	Aspiración	74	81	86	91	94	96	97	90	102
BOX HB 125 T4 (A7:4) (34º)	Aspiración	74	81	86	91	94	96	97	89	102
BOX HB 125 T4 (A7:4) (36º)	Aspiración	75	82	87	91	94	96	97	89	102
BOX HB 125 T4 (A7:4) (38º)	Aspiración	76	83	88	92	95	97	98	90	103
BOX HB 125 T4 (A7:4) (40º)	Aspiración	76	83	88	93	95	98	98	91	103
BOX HB 125 T4 (A7:4) (42º)	Aspiración	77	84	89	93	96	98	98	91	104
BOX HB 125 T4 (A7:8) (20º)	Aspiración	78	86	93	101	108	111	110	105	115
BOX HB 125 T4 (A7:8) (22º)	Aspiración	78	86	92	101	107	110	109	104	114
BOX HB 125 T4 (A7:8) (24º)	Aspiración	78	85	92	99	106	108	108	102	113
BOX HB 125 T4 (A7:8) (26º)	Aspiración	78	85	91	99	104	107	107	101	112
BOX HB 125 T4 (A7:8) (28º)	Aspiración	78	84	91	98	103	106	106	99	110
BOX HB 125 T4 (A7:8) (30º)	Aspiración	78	83	90	96	101	104	104	98	109
BOX HB 125 T4 (A7:8) (32º)	Aspiración	78	84	90	95	100	102	103	95	107
BOX HB 125 T4 (A7:8) (34º)	Aspiración	78	84	90	95	99	101	101	93	106
BOX HB 125 T4 (A7:8) (36º)	Aspiración	78	85	90	95	98	100	100	92	105
BOX HB 125 T4 (A7:8) (38º)	Aspiración	78	85	90	95	99	100	100	92	105
BOX HB 125 T4 (A7:8) (40º)	Aspiración	78	85	90	95	98	100	99	92	105
BOX HB 125 T4 (A7:8) (42º)	Aspiración	78	85	90	95	98	100	98	91	105

sonido / 6 polos

Potencia sonora Lw dB (A)										
Modelo		63 Hz	125 Hz	250 Hz	500 Hz	1000 Hz	2000 Hz	4000 Hz	8000 Hz	Total
BOX HB 45 M6 (A0:6) (25º)	Aspiración	62	61	59	60	61	60	62	59	70
BOX HB 45 M6 (A0:6) (30º)	Aspiración	66	63	61	62	62	61	63	60	72
BOX HB 45 M6 (A0:6) (35º)	Aspiración	62	60	58	57	57	56	58	53	67
BOX HB 45 M6 (A0:6) (40º)	Aspiración	65	62	60	58	58	57	58	54	69
BOX HB 45 T6 (A0:6) (25º)	Aspiración	62	61	59	60	61	60	62	59	70
BOX HB 45 T6 (A0:6) (30º)	Aspiración	66	63	61	62	62	61	63	60	72
BOX HB 45 T6 (A0:6) (35º)	Aspiración	62	60	58	57	57	56	58	53	67
BOX HB 45 T6 (A0:6) (40º)	Aspiración	65	62	60	58	58	57	58	54	69
BOX HB 50 M6 (A0:6) (25º)	Aspiración	66	65	64	66	68	68	68	65	76
BOX HB 50 M6 (A0:6) (30º)	Aspiración	67	65	64	64	65	64	65	62	74
BOX HB 50 T6 (A0:6) (25º)	Aspiración	66	65	64	66	68	68	68	65	76

Potencia sonora Lw dB (A)										
Modelo		63 Hz	125 Hz	250 Hz	500 Hz	1000 Hz	2000 Hz	4000 Hz	8000 Hz	Total
BOX HB 50 T6 (A0:6) (30º)	Aspiración	67	65	64	64	65	64	65	62	74
BOX HB 56 M6 (A2:6) (20º)	Aspiración	38	46	55	65	66	66	68	63	73
BOX HB 56 M6 (A2:6) (25º)	Aspiración	41	49	57	65	66	67	68	63	73
BOX HB 56 M6 (A2:6) (27º)	Aspiración	42	49	57	64	66	67	68	63	73
BOX HB 56 M6 (A2:6) (30º)	Aspiración	43	50	56	62	64	66	67	61	72
BOX HB 56 M6 (A2:6) (33º)	Aspiración	44	51	56	62	64	66	67	61	72
BOX HB 56 M6 (A2:6) (35º)	Aspiración	44	51	56	62	64	66	67	62	72
BOX HB 56 M6 (A2:6) (37º)	Aspiración	45	52	57	63	65	67	67	61	72
BOX HB 56 M6 (A2:6) (40º)	Aspiración	46	53	58	63	65	67	68	61	72
BOX HB 56 M6 (A2:6) (43º)	Aspiración	47	52	59	63	66	68	68	62	73
BOX HB 56 M6 (A2:6) (45º)	Aspiración	48	51	60	63	66	68	68	62	73
BOX HB 56 M6 (A2:9) (20º)	Aspiración	45	50	58	65	68	68	68	60	74
BOX HB 56 M6 (A2:9) (25º)	Aspiración	45	50	58	64	67	68	69	62	74
BOX HB 56 M6 (A2:9) (27º)	Aspiración	45	50	58	65	68	68	69	63	74
BOX HB 56 M6 (A2:9) (30º)	Aspiración	45	51	59	65	68	68	70	64	75
BOX HB 56 M6 (A2:9) (33º)	Aspiración	45	50	59	65	68	68	70	64	75
BOX HB 56 M6 (A2:9) (35º)	Aspiración	44	50	59	65	68	68	70	64	75
BOX HB 56 M6 (A2:9) (37º)	Aspiración	44	51	60	64	68	68	70	64	75
BOX HB 56 M6 (A2:9) (40º)	Aspiración	44	51	60	64	68	68	69	64	74
BOX HB 56 M6 (A2:9) (43º)	Aspiración	45	51	61	65	68	69	69	64	75
BOX HB 56 M6 (A2:9) (45º)	Aspiración	45	51	62	65	67	69	69	64	75
BOX HB 56 M6 (A5:6) (20º)	Aspiración	64	71	76	77	78	76	74	66	84
BOX HB 56 M6 (A5:6) (25º)	Aspiración	51	60	65	71	73	73	74	65	80
BOX HB 56 M6 (A5:6) (30º)	Aspiración	60	70	77	79	79	77	75	67	85
BOX HB 56 M6 (A5:6) (35º)	Aspiración	48	60	65	71	72	73	74	66	79
BOX HB 56 M6 (A5:6) (40º)	Aspiración	54	67	77	83	82	76	74	65	87
BOX HB 56 M6 (A5:6) (45º)	Aspiración	58	71	86	92	89	78	74	65	94
BOX HB 56 T6 (A2:6) (20º)	Aspiración	38	46	55	65	66	66	68	63	73
BOX HB 56 T6 (A2:6) (25º)	Aspiración	41	49	57	65	66	67	68	63	73
BOX HB 56 T6 (A2:6) (27º)	Aspiración	42	49	57	64	66	67	68	63	73
BOX HB 56 T6 (A2:6) (30º)	Aspiración	43	50	56	62	64	66	67	61	72
BOX HB 56 T6 (A2:6) (33º)	Aspiración	44	51	56	62	64	66	67	61	72
BOX HB 56 T6 (A2:6) (35º)	Aspiración	44	51	56	62	64	66	67	62	72
BOX HB 56 T6 (A2:6) (37º)	Aspiración	45	52	57	63	65	67	67	61	72
BOX HB 56 T6 (A2:6) (40º)	Aspiración	46	53	58	63	65	67	68	61	72
BOX HB 56 T6 (A2:6) (43º)	Aspiración	47	52	59	63	66	68	68	62	73
BOX HB 56 T6 (A2:6) (45º)	Aspiración	48	51	60	63	66	68	68	62	73
BOX HB 56 T6 (A2:9) (20º)	Aspiración	45	50	58	65	68	68	68	60	74
BOX HB 56 T6 (A2:9) (25º)	Aspiración	45	50	58	64	67	68	69	62	74

Potencia sonora Lw dB (A)										
Modelo		63 Hz	125 Hz	250 Hz	500 Hz	1000 Hz	2000 Hz	4000 Hz	8000 Hz	Total
BOX HB 56 T6 (A2:9) (27º)	Aspiración	45	50	58	65	68	68	69	63	74
BOX HB 56 T6 (A2:9) (30º)	Aspiración	45	51	59	65	68	68	70	64	75
BOX HB 56 T6 (A2:9) (33º)	Aspiración	45	50	59	65	68	68	70	64	75
BOX HB 56 T6 (A2:9) (35º)	Aspiración	44	50	59	65	68	68	70	64	75
BOX HB 56 T6 (A2:9) (37º)	Aspiración	44	51	60	64	68	68	70	64	75
BOX HB 56 T6 (A2:9) (40º)	Aspiración	44	51	60	64	68	68	69	64	74
BOX HB 56 T6 (A2:9) (43º)	Aspiración	45	51	61	65	68	69	69	64	75
BOX HB 56 T6 (A2:9) (45º)	Aspiración	45	51	62	65	67	69	69	64	75
BOX HB 56 T6 (A5:6) (20º)	Aspiración	64	71	76	77	78	76	74	66	84
BOX HB 56 T6 (A5:6) (25º)	Aspiración	51	60	65	71	73	73	74	65	80
BOX HB 56 T6 (A5:6) (30º)	Aspiración	60	70	77	79	79	77	75	67	85
BOX HB 56 T6 (A5:6) (35º)	Aspiración	48	60	65	71	72	73	74	66	79
BOX HB 56 T6 (A5:6) (40º)	Aspiración	54	67	77	83	82	76	74	65	87
BOX HB 56 T6 (A5:6) (45º)	Aspiración	58	71	86	92	89	78	74	65	94
BOX HB 63 T6 (A2:6) (20º)	Aspiración	40	43	55	65	65	64	67	61	72
BOX HB 63 T6 (A2:6) (25º)	Aspiración	44	49	58	67	68	68	70	65	75
BOX HB 63 T6 (A2:6) (27º)	Aspiración	44	50	58	66	67	69	69	65	75
BOX HB 63 T6 (A2:6) (30º)	Aspiración	45	52	58	65	67	69	69	64	74
BOX HB 63 T6 (A2:6) (33º)	Aspiración	45	52	57	64	66	68	69	64	74
BOX HB 63 T6 (A2:6) (35º)	Aspiración	45	52	57	64	66	68	69	63	74
BOX HB 63 T6 (A2:6) (37º)	Aspiración	46	53	58	64	66	68	69	63	74
BOX HB 63 T6 (A2:6) (40º)	Aspiración	47	53	59	65	67	69	69	63	74
BOX HB 63 T6 (A2:6) (43º)	Aspiración	49	54	61	66	69	69	69	64	75
BOX HB 63 T6 (A2:6) (45º)	Aspiración	50	54	62	66	69	70	70	64	75
BOX HB 63 T6 (A2:9) (20º)	Aspiración	49	51	62	68	70	69	71	65	76
BOX HB 63 T6 (A2:9) (25º)	Aspiración	49	52	61	68	69	70	71	66	76
BOX HB 63 T6 (A2:9) (27º)	Aspiración	49	53	61	68	70	70	71	66	76
BOX HB 63 T6 (A2:9) (30º)	Aspiración	49	54	61	68	70	71	72	67	77
BOX HB 63 T6 (A2:9) (33º)	Aspiración	49	54	61	68	70	71	72	67	77
BOX HB 63 T6 (A2:9) (35º)	Aspiración	48	55	62	68	70	72	73	67	78
BOX HB 63 T6 (A2:9) (37º)	Aspiración	49	55	61	68	70	71	72	67	77
BOX HB 63 T6 (A2:9) (40º)	Aspiración	48	55	60	67	70	71	72	67	77
BOX HB 63 T6 (A2:9) (43º)	Aspiración	48	55	60	67	70	71	72	67	77
BOX HB 63 T6 (A2:9) (45º)	Aspiración	48	55	60	67	70	71	72	67	77
BOX HB 63 T6 (A5:6) (20º)	Aspiración	67	74	79	80	81	78	77	70	87
BOX HB 63 T6 (A5:6) (25º)	Aspiración	52	61	66	71	75	74	74	68	81
BOX HB 63 T6 (A5:6) (30º)	Aspiración	55	63	73	80	78	77	77	70	85
BOX HB 63 T6 (A5:6) (35º)	Aspiración	51	63	68	72	76	75	77	70	82
BOX HB 63 T6 (A5:6) (40º)	Aspiración	52	64	75	87	84	79	77	69	90

Potencia sonora Lw dB (A)										
Modelo		63 Hz	125 Hz	250 Hz	500 Hz	1000 Hz	2000 Hz	4000 Hz	8000 Hz	Total
BOX HB 63 T6 (A5:6) (45º)	Aspiración	53	64	80	98	90	82	77	69	98
BOX HB 71 T6 (A2:6) (20º)	Aspiración	46	52	63	71	74	73	75	69	80
BOX HB 71 T6 (A2:6) (25º)	Aspiración	48	54	63	70	73	73	74	69	79
BOX HB 71 T6 (A2:6) (27º)	Aspiración	48	55	62	70	72	73	74	69	79
BOX HB 71 T6 (A2:6) (30º)	Aspiración	49	56	61	69	70	72	73	68	78
BOX HB 71 T6 (A2:6) (33º)	Aspiración	49	56	61	68	70	72	72	67	77
BOX HB 71 T6 (A2:6) (35º)	Aspiración	48	55	60	67	69	71	71	65	76
BOX HB 71 T6 (A2:6) (37º)	Aspiración	50	57	62	67	70	71	72	66	77
BOX HB 71 T6 (A2:6) (40º)	Aspiración	51	57	63	68	71	72	72	66	78
BOX HB 71 T6 (A2:6) (43º)	Aspiración	52	57	64	68	71	72	72	66	78
BOX HB 71 T6 (A2:6) (45º)	Aspiración	53	57	65	69	72	72	72	65	78
BOX HB 71 T6 (A2:9) (20º)	Aspiración	52	58	67	74	77	76	78	71	83
BOX HB 71 T6 (A2:9) (25º)	Aspiración	52	58	65	73	75	75	77	70	81
BOX HB 71 T6 (A2:9) (27º)	Aspiración	52	58	65	72	74	75	76	70	81
BOX HB 71 T6 (A2:9) (30º)	Aspiración	52	58	64	71	73	74	75	70	80
BOX HB 71 T6 (A2:9) (33º)	Aspiración	51	58	63	71	73	74	75	69	80
BOX HB 71 T6 (A2:9) (35º)	Aspiración	51	58	63	71	74	75	75	69	80
BOX HB 71 T6 (A2:9) (37º)	Aspiración	52	59	64	70	74	75	75	69	80
BOX HB 71 T6 (A2:9) (40º)	Aspiración	53	60	65	70	74	75	75	69	80
BOX HB 71 T6 (A2:9) (43º)	Aspiración	52	59	64	70	73	74	74	68	80
BOX HB 71 T6 (A2:9) (45º)	Aspiración	51	59	64	70	73	74	74	68	79
BOX HB 71 T6 (A5:6) (20º)	Aspiración	69	76	81	83	83	81	80	73	90
BOX HB 71 T6 (A5:6) (25º)	Aspiración	56	66	72	76	79	80	80	71	86
BOX HB 71 T6 (A5:6) (30º)	Aspiración	58	66	73	79	80	79	79	70	86
BOX HB 71 T6 (A5:6) (35º)	Aspiración	51	63	68	73	76	77	78	69	83
BOX HB 71 T6 (A5:6) (40º)	Aspiración	55	66	81	90	86	81	79	70	93
BOX HB 71 T6 (A5:6) (45º)	Aspiración	59	68	90	103	94	85	81	70	103
BOX HB 80 T6 (A2:6) (20º)	Aspiración	46	52	63	71	75	74	76	71	81
BOX HB 80 T6 (A2:6) (25º)	Aspiración	49	56	63	71	74	75	76	70	81
BOX HB 80 T6 (A2:6) (27º)	Aspiración	50	57	63	71	74	75	76	70	81
BOX HB 80 T6 (A2:6) (30º)	Aspiración	51	58	63	70	73	75	76	69	80
BOX HB 80 T6 (A2:6) (33º)	Aspiración	52	59	64	70	73	75	75	69	80
BOX HB 80 T6 (A2:6) (35º)	Aspiración	53	60	65	70	73	75	75	68	80
BOX HB 80 T6 (A2:6) (37º)	Aspiración	53	60	65	70	73	74	74	68	80
BOX HB 80 T6 (A2:6) (40º)	Aspiración	53	61	66	70	73	74	73	67	79
BOX HB 80 T6 (A2:6) (43º)	Aspiración	53	61	67	70	73	74	74	67	79
BOX HB 80 T6 (A2:6) (45º)	Aspiración	53	61	67	70	73	74	74	67	80
BOX HB 80 T6 (A2:9) (20º)	Aspiración	51	63	69	81	83	81	83	75	88
BOX HB 80 T6 (A2:9) (25º)	Aspiración	53	63	68	78	80	80	81	74	86

Potencia sonora Lw dB (A)

Modelo		63 Hz	125 Hz	250 Hz	500 Hz	1000 Hz	2000 Hz	4000 Hz	8000 Hz	Total
BOX HB 80 T6 (A2:9) (27º)	Aspiración	54	63	68	77	80	80	81	74	86
BOX HB 80 T6 (A2:9) (30º)	Aspiración	55	62	67	75	78	79	80	74	85
BOX HB 80 T6 (A2:9) (33º)	Aspiración	54	61	66	74	78	79	79	73	84
BOX HB 80 T6 (A2:9) (35º)	Aspiración	54	61	66	73	77	78	78	72	83
BOX HB 80 T6 (A2:9) (37º)	Aspiración	55	62	67	72	76	78	77	71	83
BOX HB 80 T6 (A2:9) (40º)	Aspiración	56	63	68	72	76	78	77	71	83
BOX HB 80 T6 (A2:9) (43º)	Aspiración	56	63	68	72	75	77	76	70	82
BOX HB 80 T6 (A2:9) (45º)	Aspiración	55	63	68	72	75	76	75	70	82
BOX HB 80 T6 (A5:6) (20º)	Aspiración	72	79	84	86	86	84	83	76	92
BOX HB 80 T6 (A5:6) (25º)	Aspiración	59	66	72	77	79	79	80	72	86
BOX HB 80 T6 (A5:6) (30º)	Aspiración	59	70	77	87	85	83	83	75	92
BOX HB 80 T6 (A5:6) (35º)	Aspiración	56	68	74	82	87	85	85	76	92
BOX HB 80 T6 (A5:6) (40º)	Aspiración	57	70	86	91	88	84	82	74	95
BOX HB 80 T6 (A5:6) (45º)	Aspiración	58	72	95	98	89	84	80	73	100
BOX HB 90 T6 (A6:3) (20º)	Aspiración	51	55	63	66	71	72	75	69	79
BOX HB 90 T6 (A6:3) (22º)	Aspiración	53	57	65	68	72	73	76	70	80
BOX HB 90 T6 (A6:3) (24º)	Aspiración	54	58	66	70	73	75	77	71	81
BOX HB 90 T6 (A6:3) (26º)	Aspiración	55	59	67	72	75	76	78	72	82
BOX HB 90 T6 (A6:3) (28º)	Aspiración	56	61	68	74	76	77	79	73	83
BOX HB 90 T6 (A6:3) (30º)	Aspiración	57	62	69	76	77	78	80	74	84
BOX HB 90 T6 (A6:3) (32º)	Aspiración	57	63	70	77	77	79	80	74	85
BOX HB 90 T6 (A6:3) (34º)	Aspiración	57	63	70	78	78	79	80	74	86
BOX HB 90 T6 (A6:3) (36º)	Aspiración	57	64	71	79	79	80	81	75	86
BOX HB 90 T6 (A6:3) (38º)	Aspiración	57	65	72	80	80	81	82	76	87
BOX HB 90 T6 (A6:3) (40º)	Aspiración	58	66	72	81	81	82	83	77	88
BOX HB 90 T6 (A6:3) (42º)	Aspiración	58	66	73	81	82	83	83	78	89
BOX HB 90 T6 (A6:6) (20º)	Aspiración	56	66	72	80	84	82	82	77	89
BOX HB 90 T6 (A6:6) (22º)	Aspiración	57	67	73	80	84	82	83	78	89
BOX HB 90 T6 (A6:6) (24º)	Aspiración	58	68	73	81	84	83	83	79	89
BOX HB 90 T6 (A6:6) (26º)	Aspiración	59	68	74	81	84	83	84	79	90
BOX HB 90 T6 (A6:6) (28º)	Aspiración	60	69	74	82	83	83	84	80	90
BOX HB 90 T6 (A6:6) (30º)	Aspiración	60	69	75	82	83	83	85	80	90
BOX HB 90 T6 (A6:6) (32º)	Aspiración	59	68	73	80	81	82	83	78	88
BOX HB 90 T6 (A6:6) (34º)	Aspiración	58	67	72	78	80	80	82	77	87
BOX HB 90 T6 (A6:6) (36º)	Aspiración	57	66	71	78	79	80	82	76	87
BOX HB 90 T6 (A6:6) (38º)	Aspiración	58	67	72	78	80	81	82	77	87
BOX HB 90 T6 (A6:6) (40º)	Aspiración	59	68	73	79	80	81	83	77	88
BOX HB 90 T6 (A6:6) (42º)	Aspiración	59	68	74	79	81	82	83	77	88
BOX HB 100 T6 (A6:3) (20º)	Aspiración	56	66	72	80	84	82	82	77	89

Potencia sonora Lw dB (A)

Modelo		63 Hz	125 Hz	250 Hz	500 Hz	1000 Hz	2000 Hz	4000 Hz	8000 Hz	Total
BOX HB 100 T6 (A6:3) (22º)	Aspiración	57	67	73	80	84	82	83	78	89
BOX HB 100 T6 (A6:3) (24º)	Aspiración	58	68	73	81	84	83	83	79	89
BOX HB 100 T6 (A6:3) (26º)	Aspiración	59	68	74	81	84	83	84	79	90
BOX HB 100 T6 (A6:3) (28º)	Aspiración	60	69	74	82	83	83	84	80	90
BOX HB 100 T6 (A6:3) (30º)	Aspiración	60	69	75	82	83	83	85	80	90
BOX HB 100 T6 (A6:3) (32º)	Aspiración	59	68	73	80	81	82	83	78	88
BOX HB 100 T6 (A6:3) (34º)	Aspiración	58	67	72	78	80	80	82	77	87
BOX HB 100 T6 (A6:3) (36º)	Aspiración	57	66	71	78	79	80	82	76	87
BOX HB 100 T6 (A6:3) (38º)	Aspiración	58	67	72	78	80	81	82	77	87
BOX HB 100 T6 (A6:3) (40º)	Aspiración	59	68	73	79	80	81	83	77	88
BOX HB 100 T6 (A6:3) (42º)	Aspiración	59	68	74	79	81	82	83	77	88
BOX HB 100 T6 (A6:6) (20º)	Aspiración	60	71	76	87	87	87	87	83	93
BOX HB 100 T6 (A6:6) (22º)	Aspiración	61	71	76	86	87	86	87	82	93
BOX HB 100 T6 (A6:6) (24º)	Aspiración	61	71	77	86	86	86	87	82	93
BOX HB 100 T6 (A6:6) (26º)	Aspiración	63	72	78	86	87	87	87	83	93
BOX HB 100 T6 (A6:6) (28º)	Aspiración	64	73	78	86	87	87	88	83	94
BOX HB 100 T6 (A6:6) (30º)	Aspiración	65	73	79	86	86	87	88	83	93
BOX HB 100 T6 (A6:6) (32º)	Aspiración	64	72	78	83	85	85	87	82	92
BOX HB 100 T6 (A6:6) (34º)	Aspiración	63	71	77	81	84	84	86	80	91
BOX HB 100 T6 (A6:6) (36º)	Aspiración	63	71	77	81	83	84	85	80	90
BOX HB 100 T6 (A6:6) (38º)	Aspiración	63	71	77	82	84	85	86	80	91
BOX HB 100 T6 (A6:6) (40º)	Aspiración	64	72	78	83	85	85	86	81	92
BOX HB 100 T6 (A6:6) (42º)	Aspiración	64	72	78	83	84	85	86	80	91
BOX HB 112 T6 (A6:3) (20º)	Aspiración	59	66	71	78	83	84	86	81	90
BOX HB 112 T6 (A6:3) (22º)	Aspiración	60	67	72	79	83	84	86	81	91
BOX HB 112 T6 (A6:3) (24º)	Aspiración	61	68	73	80	84	85	87	82	91
BOX HB 112 T6 (A6:3) (26º)	Aspiración	62	69	74	80	84	85	87	82	91
BOX HB 112 T6 (A6:3) (28º)	Aspiración	63	69	75	81	84	84	87	82	91
BOX HB 112 T6 (A6:3) (30º)	Aspiración	63	68	75	80	83	84	86	81	91
BOX HB 112 T6 (A6:3) (32º)	Aspiración	63	68	75	81	83	84	86	81	91
BOX HB 112 T6 (A6:3) (34º)	Aspiración	64	69	76	81	83	84	86	81	91
BOX HB 112 T6 (A6:3) (36º)	Aspiración	64	69	76	82	84	84	86	81	91
BOX HB 112 T6 (A6:3) (38º)	Aspiración	64	70	76	82	84	85	86	81	91
BOX HB 112 T6 (A6:3) (40º)	Aspiración	64	70	76	83	85	85	86	81	91
BOX HB 112 T6 (A6:3) (42º)	Aspiración	64	71	76	83	85	86	86	82	92
BOX HB 112 T6 (A6:6) (20º)	Aspiración	61	72	77	89	90	88	89	84	95
BOX HB 112 T6 (A6:6) (22º)	Aspiración	62	72	77	88	89	88	89	84	95
BOX HB 112 T6 (A6:6) (24º)	Aspiración	62	72	77	87	88	88	89	83	94
BOX HB 112 T6 (A6:6) (26º)	Aspiración	64	73	78	87	88	88	89	83	95

Potencia sonora Lw dB (A)

Modelo		63 Hz	125 Hz	250 Hz	500 Hz	1000 Hz	2000 Hz	4000 Hz	8000 Hz	Total
BOX HB 112 T6 (A6:6) (28º)	Aspiración	65	73	78	86	88	89	89	83	95
BOX HB 112 T6 (A6:6) (30º)	Aspiración	66	73	78	86	88	88	89	83	94
BOX HB 112 T6 (A6:6) (32º)	Aspiración	66	73	78	84	86	88	88	81	93
BOX HB 112 T6 (A6:6) (34º)	Aspiración	66	73	78	82	85	87	88	80	92
BOX HB 112 T6 (A6:6) (36º)	Aspiración	66	73	78	82	85	87	88	81	93
BOX HB 112 T6 (A6:6) (38º)	Aspiración	68	75	80	84	87	88	89	82	94
BOX HB 112 T6 (A6:6) (40º)	Aspiración	70	76	82	86	88	89	90	83	95
BOX HB 112 T6 (A6:6) (42º)	Aspiración	70	75	82	86	88	89	90	83	95
BOX HB 125 T6 (A7:4) (20º)	Aspiración	63	77	82	89	93	93	95	92	100
BOX HB 125 T6 (A7:4) (22º)	Aspiración	66	78	83	90	93	94	96	92	101
BOX HB 125 T6 (A7:4) (24º)	Aspiración	67	76	81	88	91	92	94	89	99
BOX HB 125 T6 (A7:4) (26º)	Aspiración	67	75	80	86	89	90	92	87	97
BOX HB 125 T6 (A7:4) (28º)	Aspiración	67	74	79	84	88	89	90	85	95
BOX HB 125 T6 (A7:4) (30º)	Aspiración	65	72	77	82	86	87	88	82	93
BOX HB 125 T6 (A7:4) (32º)	Aspiración	65	72	77	81	85	87	87	81	92
BOX HB 125 T6 (A7:4) (34º)	Aspiración	65	72	77	81	84	86	87	80	92
BOX HB 125 T6 (A7:4) (36º)	Aspiración	65	72	77	82	85	86	87	80	92
BOX HB 125 T6 (A7:4) (38º)	Aspiración	66	73	78	83	85	87	88	81	93
BOX HB 125 T6 (A7:4) (40º)	Aspiración	67	74	79	83	85	88	88	81	93
BOX HB 125 T6 (A7:4) (42º)	Aspiración	67	74	79	84	86	89	88	82	94
BOX HB 125 T6 (A7:8) (20º)	Aspiración	69	77	83	92	99	102	101	95	106
BOX HB 125 T6 (A7:8) (22º)	Aspiración	69	76	83	91	98	100	100	94	105
BOX HB 125 T6 (A7:8) (24º)	Aspiración	69	76	82	90	96	99	98	92	103
BOX HB 125 T6 (A7:8) (26º)	Aspiración	69	75	82	89	94	98	97	91	102
BOX HB 125 T6 (A7:8) (28º)	Aspiración	69	75	81	88	93	96	96	89	101
BOX HB 125 T6 (A7:8) (30º)	Aspiración	68	74	80	86	91	94	94	88	99
BOX HB 125 T6 (A7:8) (32º)	Aspiración	68	74	81	86	90	93	93	86	98
BOX HB 125 T6 (A7:8) (34º)	Aspiración	69	75	81	86	89	91	91	84	96
BOX HB 125 T6 (A7:8) (36º)	Aspiración	69	75	81	86	89	91	90	83	96
BOX HB 125 T6 (A7:8) (38º)	Aspiración	69	76	81	86	89	91	90	83	95
BOX HB 125 T6 (A7:8) (40º)	Aspiración	68	75	80	85	88	90	89	82	95
BOX HB 125 T6 (A7:8) (42º)	Aspiración	68	75	80	85	88	90	88	82	95